

# Bombas de desplazamiento positivo ZP1

## ZP1 Series Positive Displacement Pumps

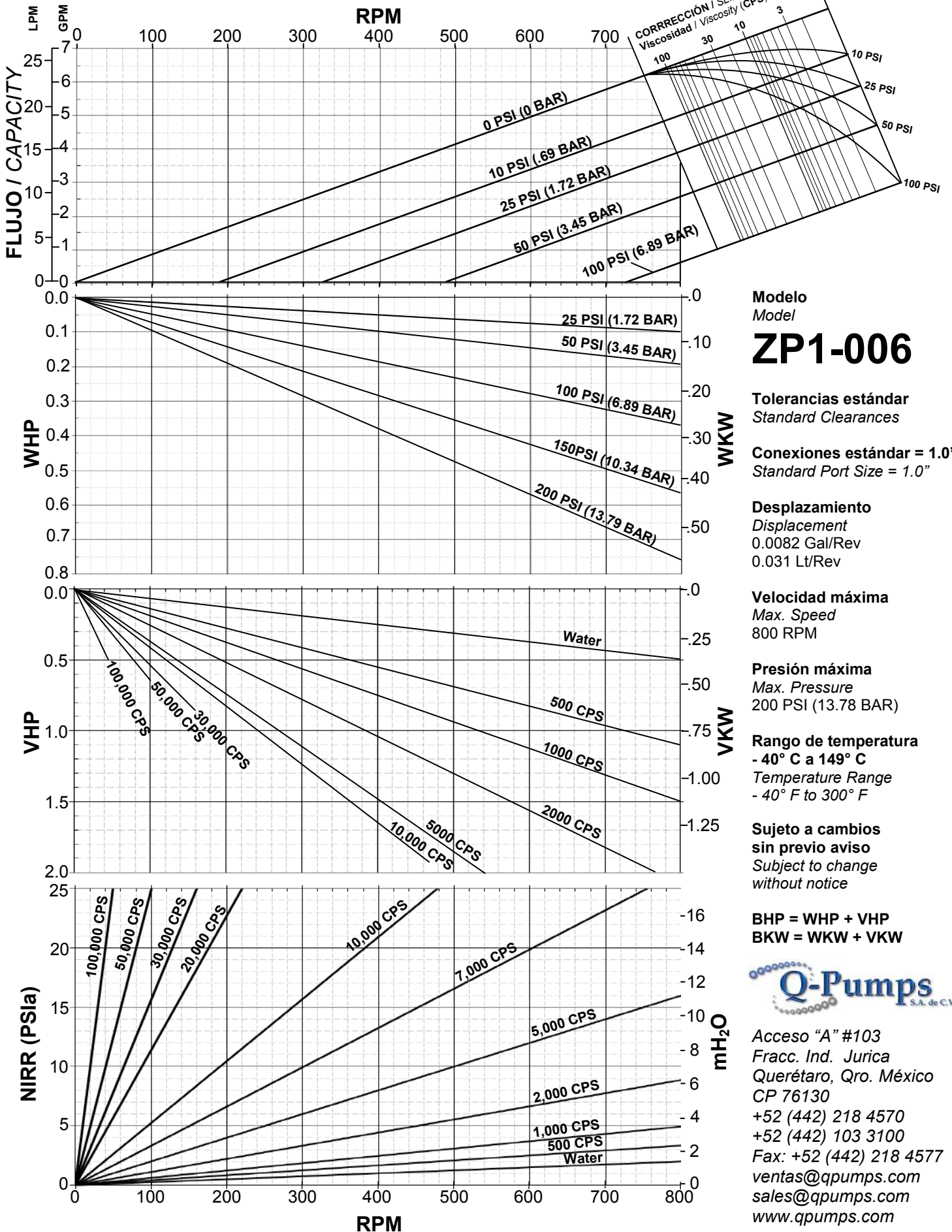

Modelo  
Model  
**ZP1-006**

Tolerancias estándar  
Standard Clearances

Conexiones estándar = 1.0"  
Standard Port Size = 1.0"

Desplazamiento  
Displacement  
0.0082 Gal/Rev  
0.031 Lt/Rev

Velocidad máxima  
Max. Speed  
800 RPM

Presión máxima  
Max. Pressure  
200 PSI (13.78 BAR)

Rango de temperatura  
- 40° C a 149° C  
Temperature Range  
- 40° F to 300° F

Sujeto a cambios  
sin previo aviso  
Subject to change  
without notice

BHP = WHP + VHP  
BKW = WKW + VKW



Acceso "A" #103  
Fracc. Ind. Jurica  
Querétaro, Qro. México  
CP 76130  
+52 (442) 218 4570  
+52 (442) 103 3100  
Fax: +52 (442) 218 4577  
ventas@qpumps.com  
sales@qpumps.com  
www.qpumps.com

# Bombas de desplazamiento positivo ZP1

## ZP1 Series Positive Displacement Pumps

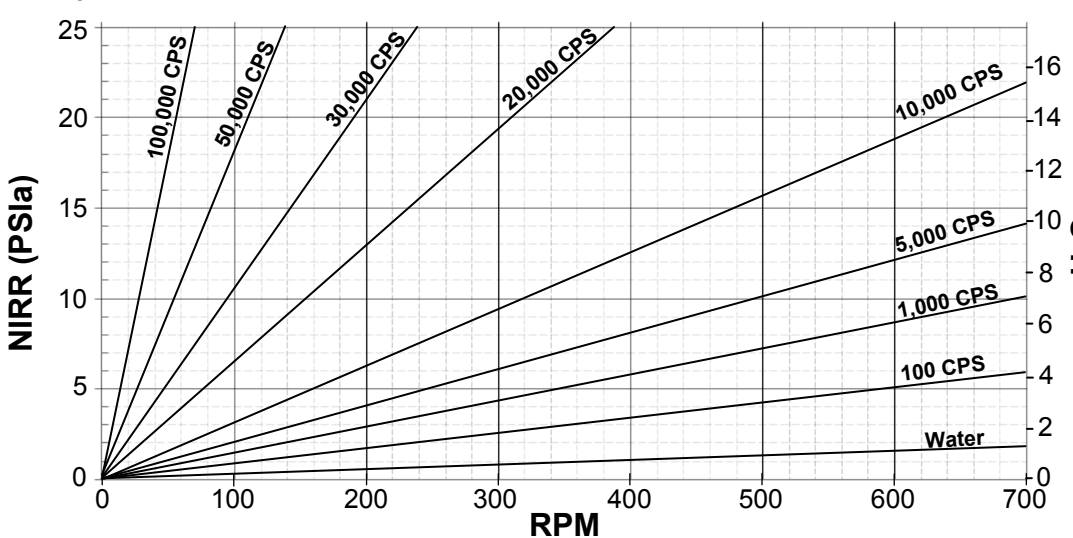
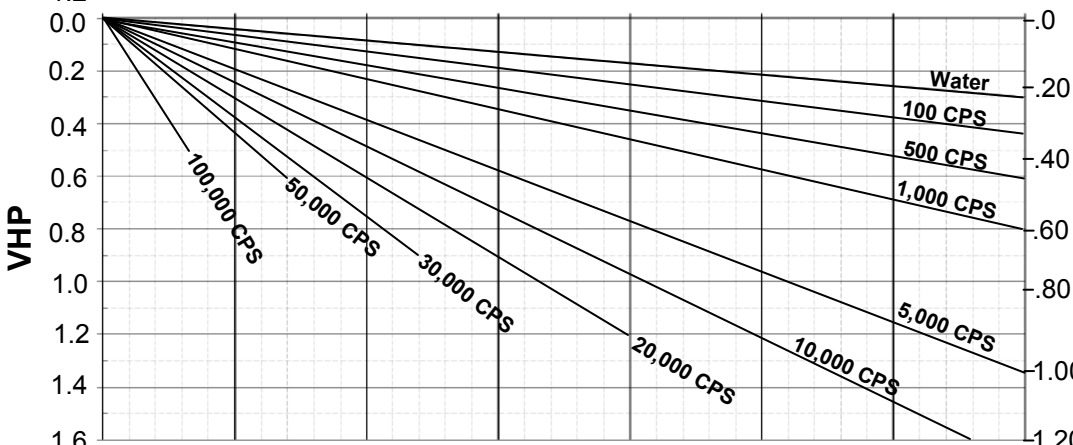
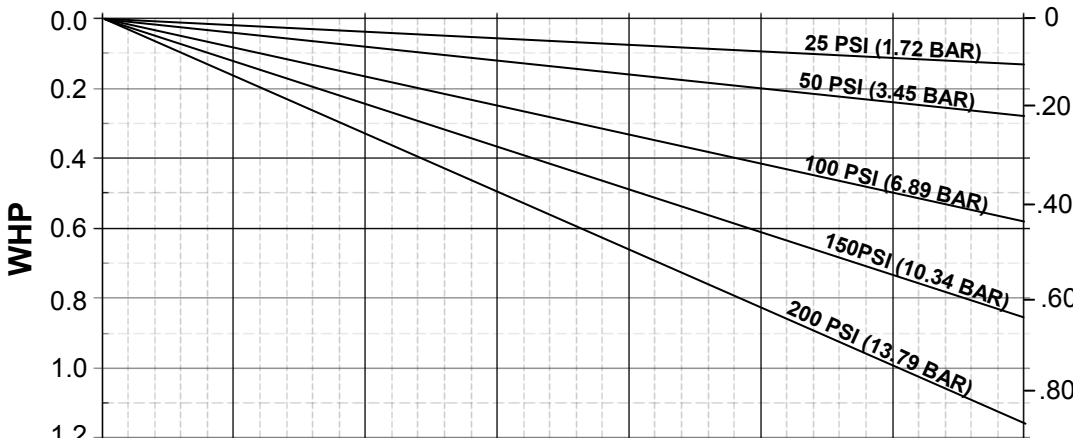
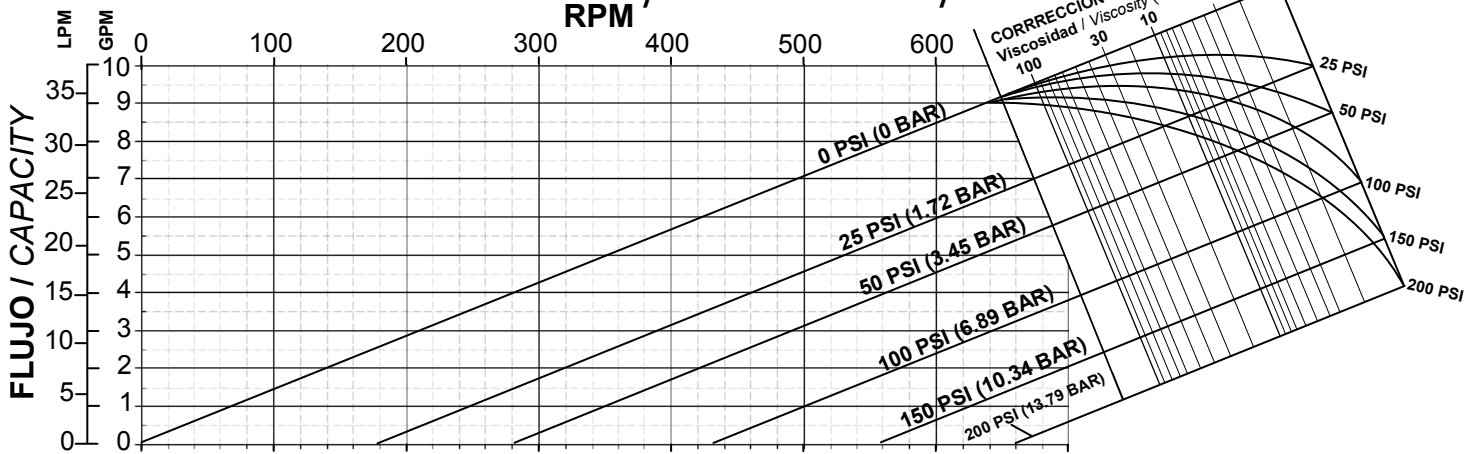

Modelo  
Model  
**ZP1-015**

Tolerancias estándar  
Standard Clearances

Conexiones estándar = 1.5"  
Standard Port Size = 1.5"

Desplazamiento  
Displacement  
0.014 Gal/Rev  
0.054 Lt/Rev

Velocidad máxima  
Max. Speed  
700 RPM

Presión máxima  
Max. Pressure  
200 PSI (13.78 BAR)

Rango de temperatura  
- 40° C a 149° C  
Temperature Range  
- 40° F to 300° F

Sujeto a cambios  
sin previo aviso  
Subject to change  
without notice

BHP = WHP + VHP  
BKW = WKW + VKW



Acceso "A" #103  
Fracc. Ind. Jurica  
Querétaro, Qro. México  
CP 76130  
+52 (442) 218 4570  
+52 (442) 103 3100  
Fax: +52 (442) 218 4577  
ventas@qpumps.com  
sales@qpumps.com  
www.qpumps.com

# Bombas de desplazamiento positivo ZP1

## ZP1 Series Positive Displacement Pumps

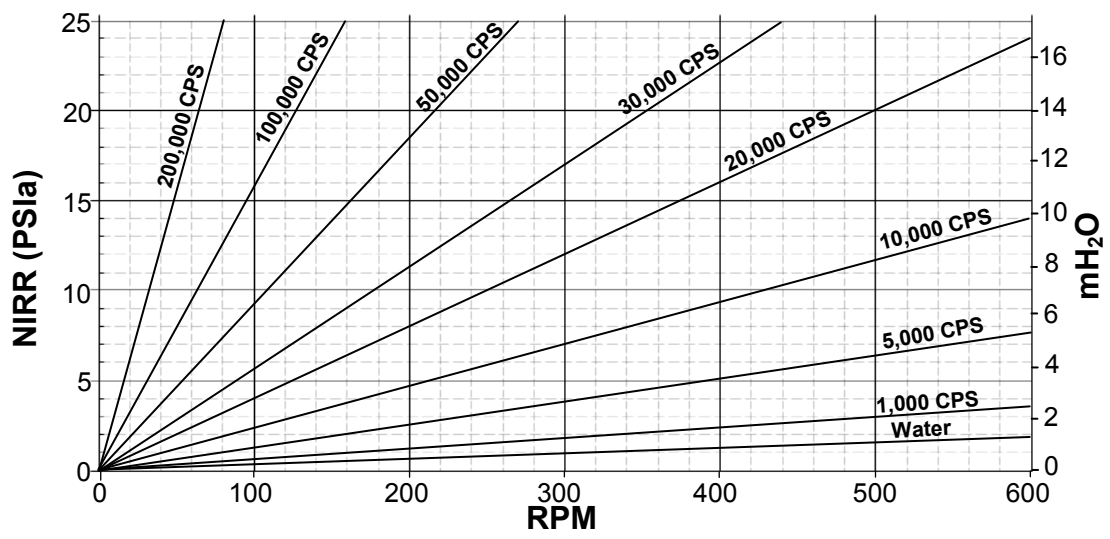
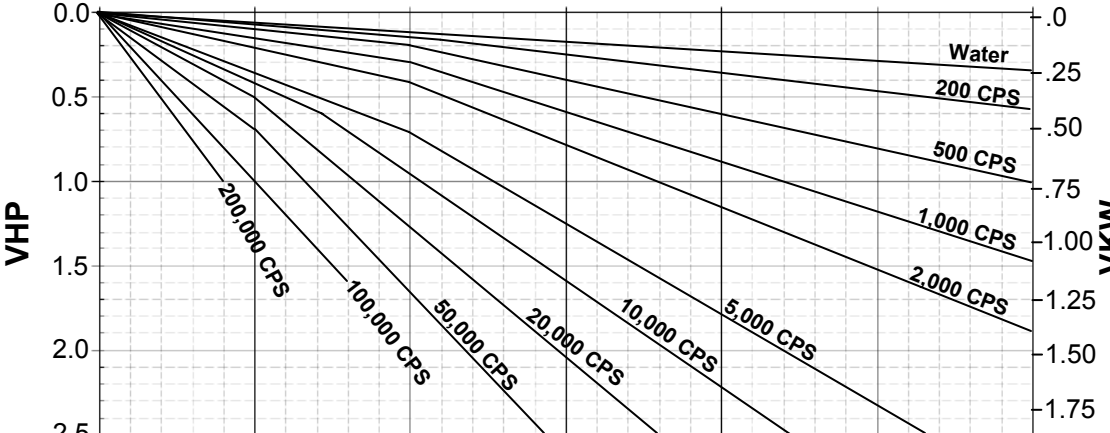
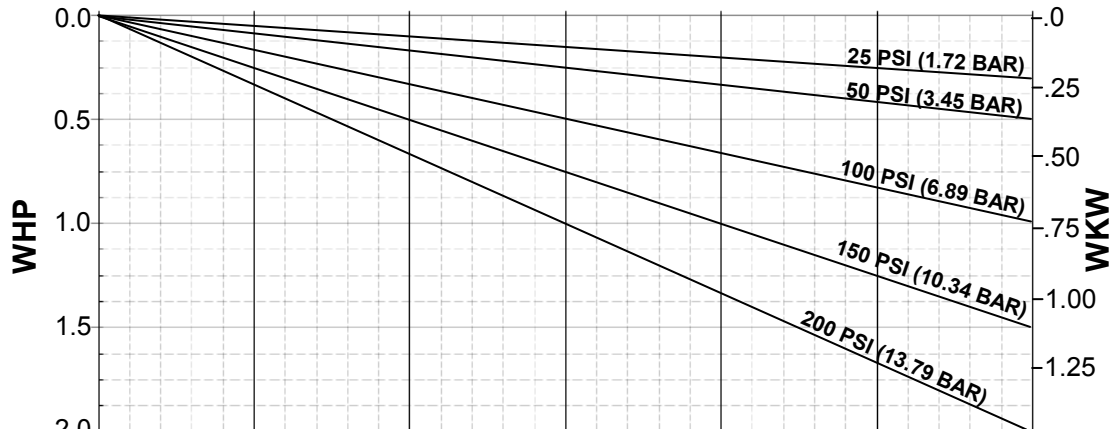
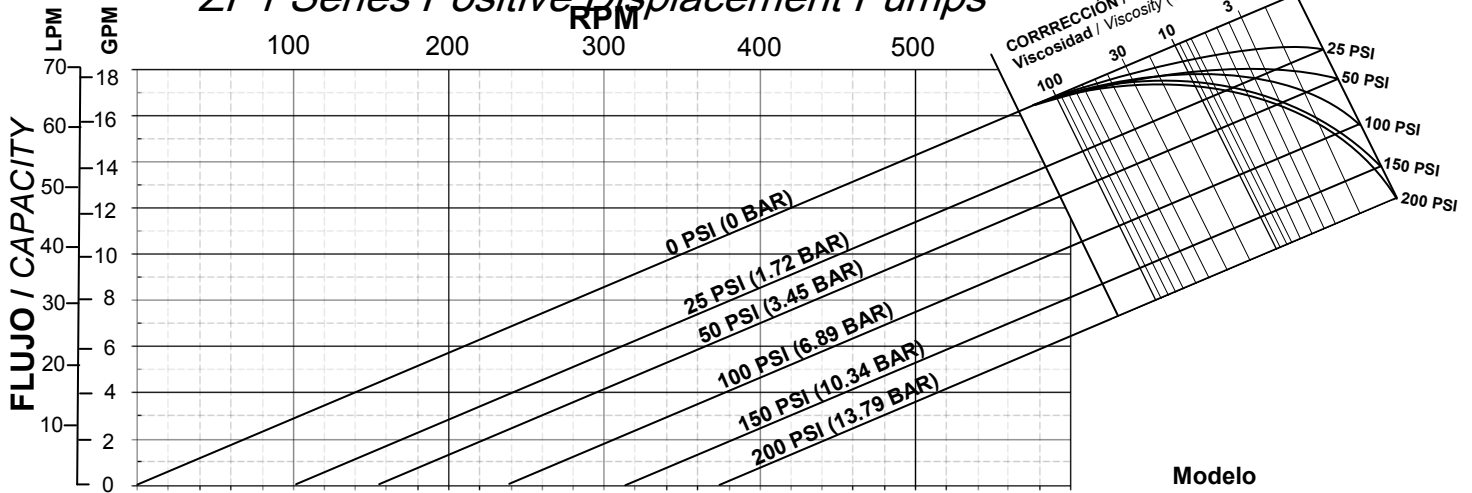

Modelo  
Model  
**ZP1-018**

Tolerancias estándar  
Standard Clearances

Conexiones estándar = 1.5"  
Standard Port Size = 1.5"

Desplazamiento  
Displacement  
0.029 Gal/Rev  
0.108 Lt/Rev

Velocidad máxima  
Max. Speed  
600 RPM

Presión máxima  
Max. Pressure  
200 PSI (13.78 BAR)

Rango de temperatura  
- 40° C a 149° C  
Temperature Range  
- 40° F to 300° F

Sujeto a cambios  
sin previo aviso  
Subject to change  
without notice

**BHP = WHP + VHP**  
**BKW = WKW + VKW**



Acceso "A" #103  
Fracc. Ind. Jurica  
Querétaro, Qro. México  
CP 76130  
+52 (442) 218 4570  
+52 (442) 103 3100  
Fax: +52 (442) 218 4577  
ventas@qpumps.com  
sales@qpumps.com  
www.qpumps.com

# Bombas de desplazamiento positivo ZP1

## ZP1 Series Positive Displacement Pumps

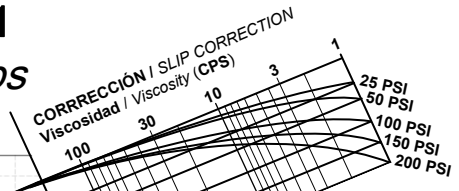
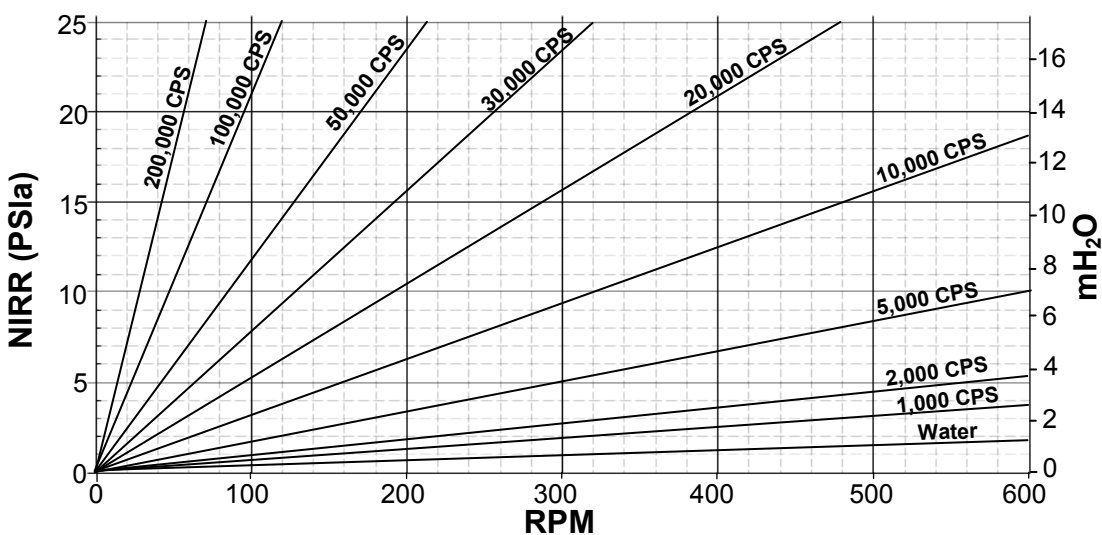
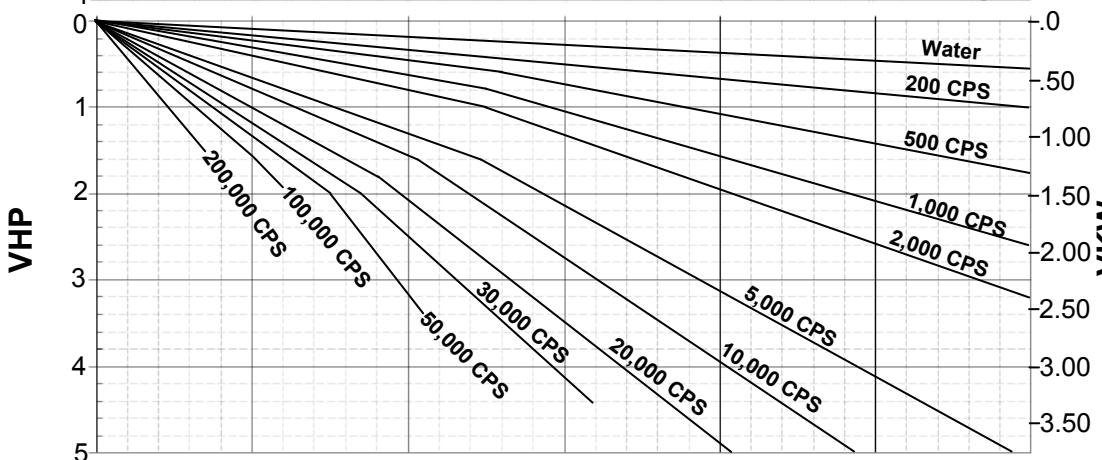
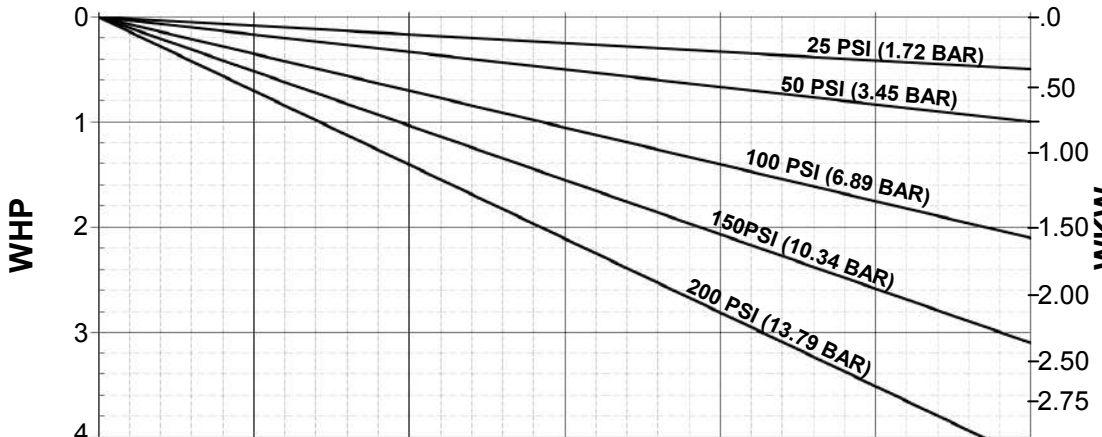
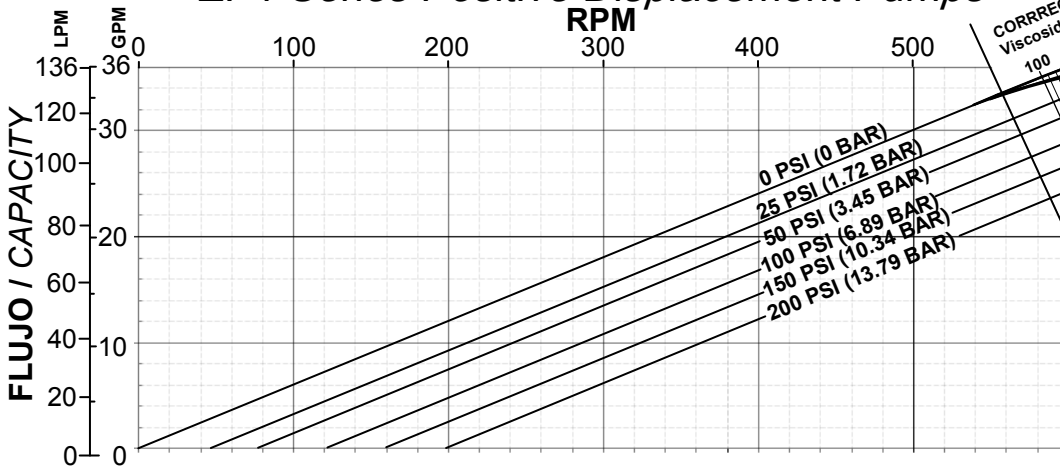

Modelo  
Model  
**ZP1-030**

Tolerancias estándar  
Standard Clearances

Conexiones estándar = 1.5"  
Standard Port Size = 1.5"

Desplazamiento  
Displacement  
0.060 Gal/Rev  
0.227 Lt/Rev

Velocidad máxima  
Max. Speed  
600 RPM

Presión máxima  
Max. Pressure  
200 PSI (13.78 BAR)

Rango de temperatura  
- 40° C a 149° C  
Temperature Range  
- 40° F to 300° F

Sujeto a cambios  
sin previo aviso  
Subject to change  
without notice

BHP = WHP + VHP  
BKW = WKW + VKW



Acceso "A" #103  
Fracc. Ind. Jurica  
Querétaro, Qro. México  
CP 76130  
+52 (442) 218 4570  
+52 (442) 103 3100  
Fax: +52 (442) 218 4577  
ventas@qpumps.com  
sales@qpumps.com  
www.qpumps.com

# Bombas de desplazamiento positivo ZP1

## ZP1 Series Positive Displacement Pumps

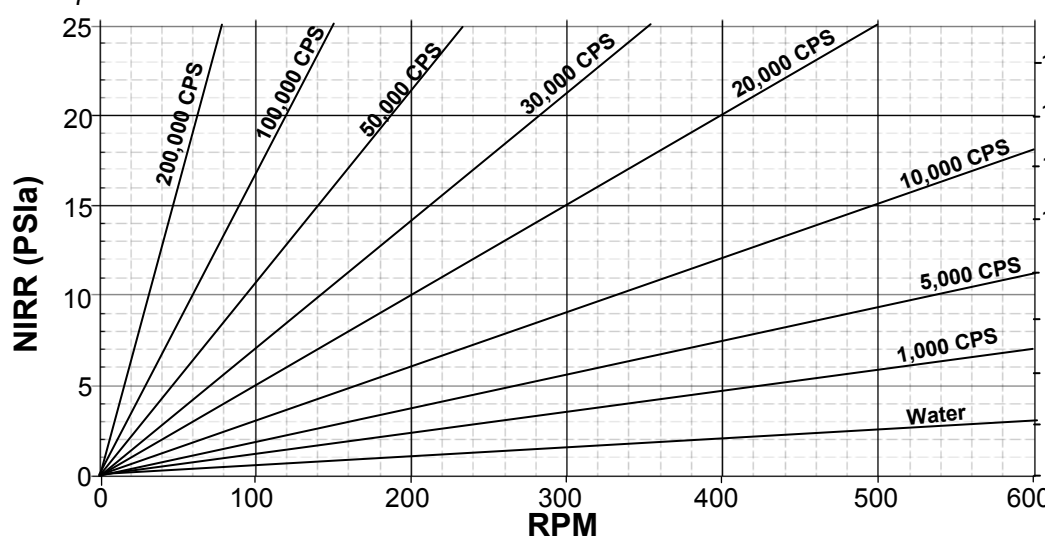
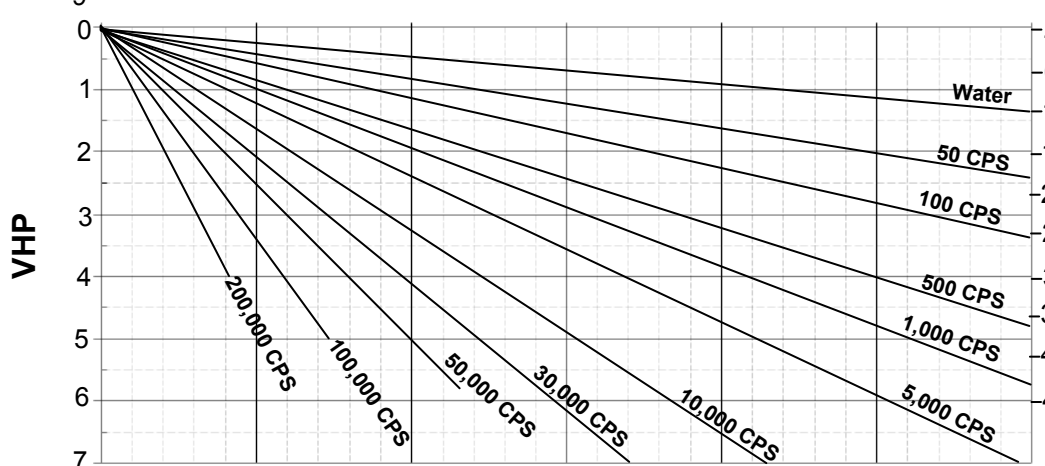
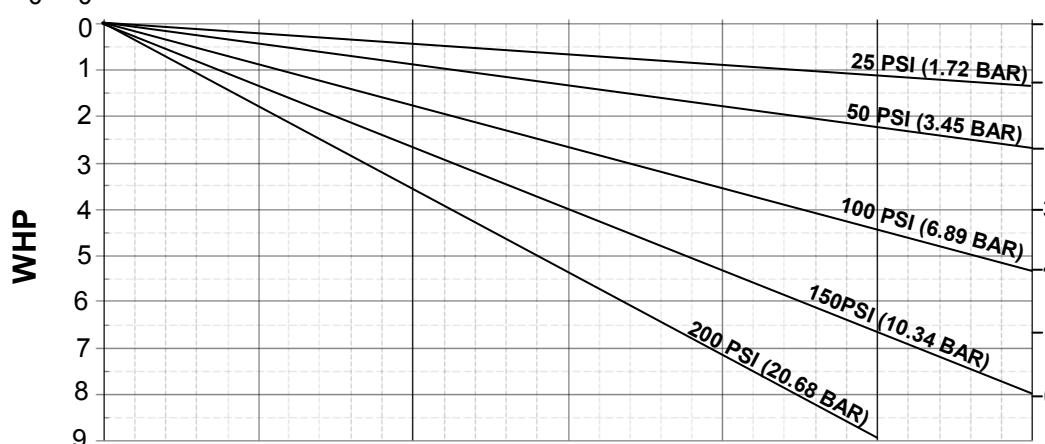
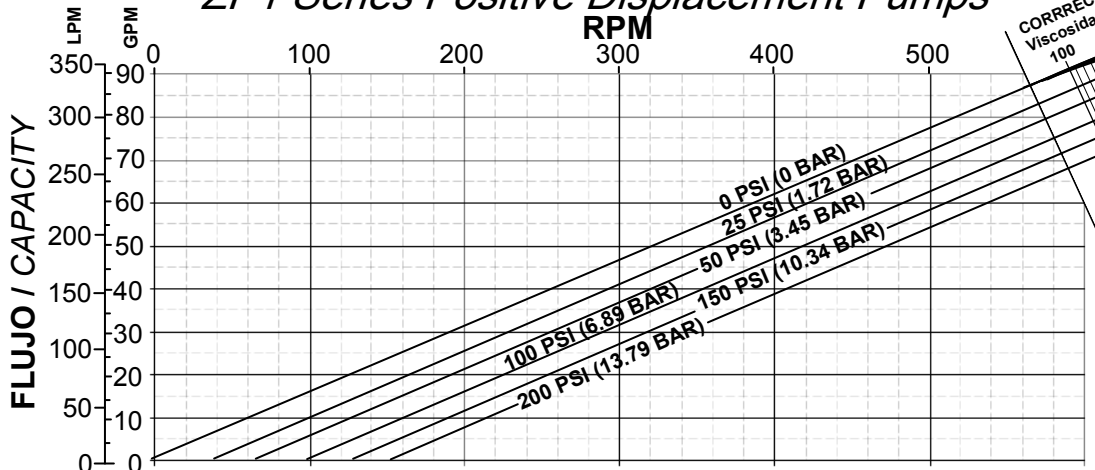

Modelo  
Model

### ZP1-060

Tolerancias estándar  
Standard Clearances

Conexiones estándar = 2.5"  
Standard Port Size = 2.5"

Desplazamiento  
Displacement  
0.153 Gal/Rev  
0.579 Lt/Rev

Velocidad máxima  
Max. Speed  
600 RPM

Presión máxima  
Max. Pressure  
200 PSI (13.78 BAR)

Rango de temperatura  
- 40° C a 149° C  
Temperature Range  
- 40° F to 300° F

Sujeto a cambios  
sin previo aviso  
Subject to change  
without notice

BHP = WHP + VHP  
BKW = WKW + VKW



Acceso "A" #103  
Fracc. Ind. Jurica  
Querétaro, Qro. México  
CP 76130  
+52 (442) 218 4570  
+52 (442) 103 3100  
Fax: +52 (442) 218 4577  
ventas@qpumps.com  
sales@qpumps.com  
www.qpumps.com

# Bombas de desplazamiento positivo ZP1

## ZP1 Series Positive Displacement Pumps

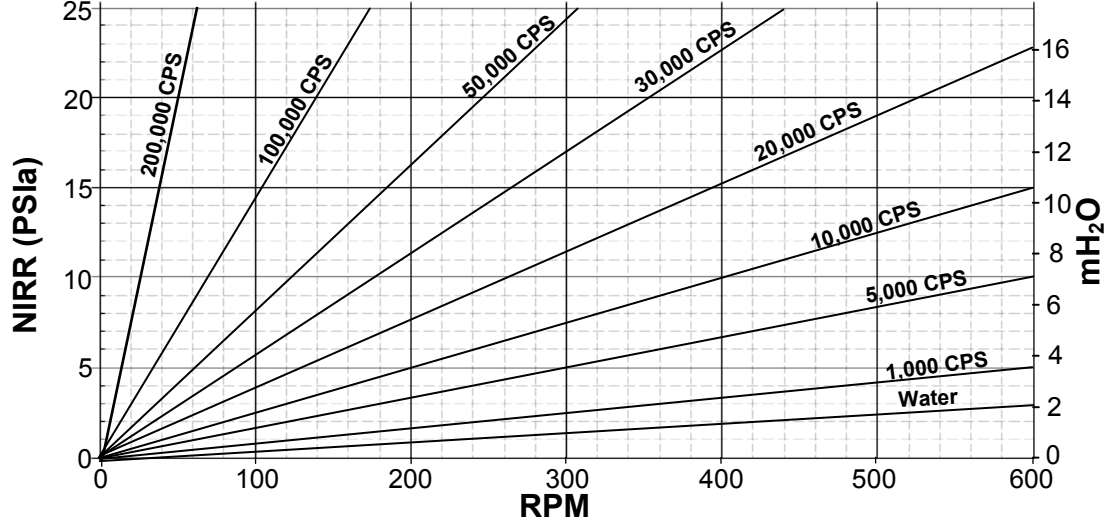
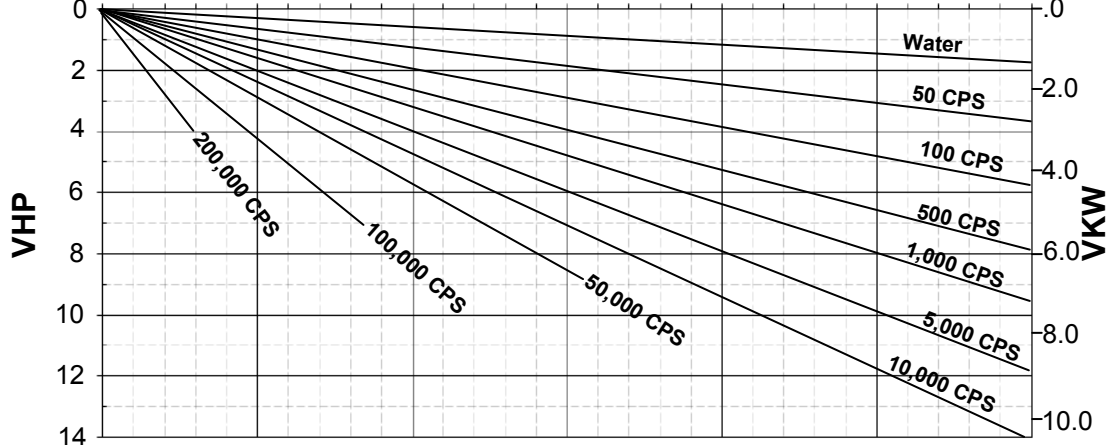
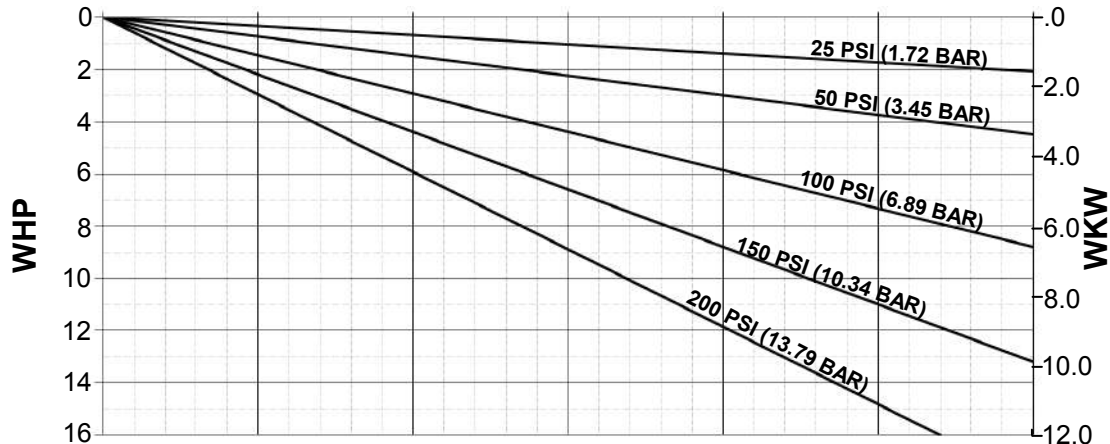
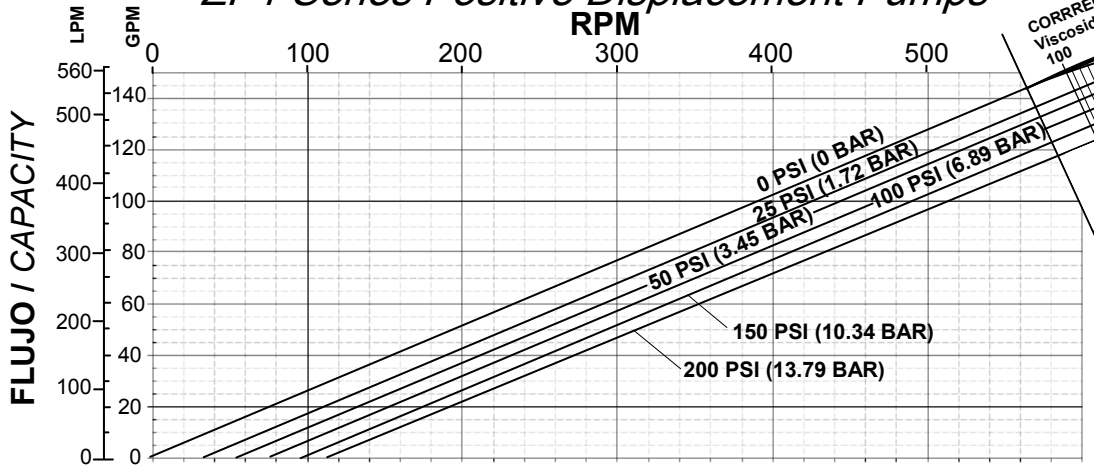

Modelo  
Model  
**ZP1-130**

Tolerancias estándar  
Standard Clearances

Conexiones estándar = 3.0"  
Standard Port Size = 3.0"

Desplazamiento  
Displacement  
0.254 Gal/Rev  
0.961 Lt/Rev

Velocidad máxima  
Max. Speed  
600 RPM

Presión máxima  
Max. Pressure  
200 PSI (13.78 BAR)

Rango de temperatura  
- 40° C a 149° C  
Temperature Range  
- 40° F to 300° F

Sujeto a cambios  
sin previo aviso  
Subject to change  
without notice

BHP = WHP + VHP  
BKW = WKW + VKW



Acceso "A" #103  
Fracc. Ind. Jurica  
Querétaro, Qro. México  
CP 76130  
+52 (442) 218 4570  
+52 (442) 103 3100  
Fax: +52 (442) 218 4577  
ventas@qpumps.com  
sales@qpumps.com  
www.qpumps.com

# Bombas de desplazamiento positivo ZP1

## ZP1 Series Positive Displacement Pumps

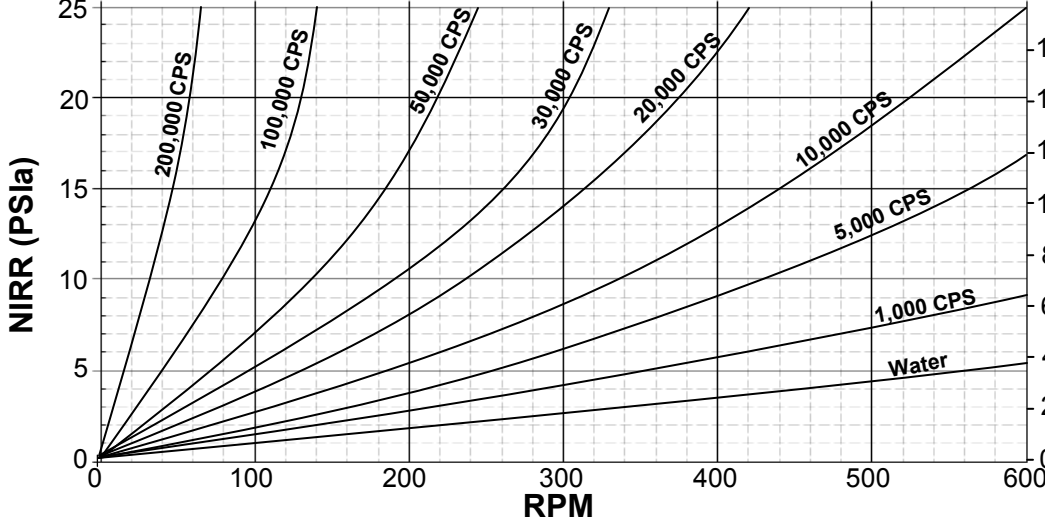
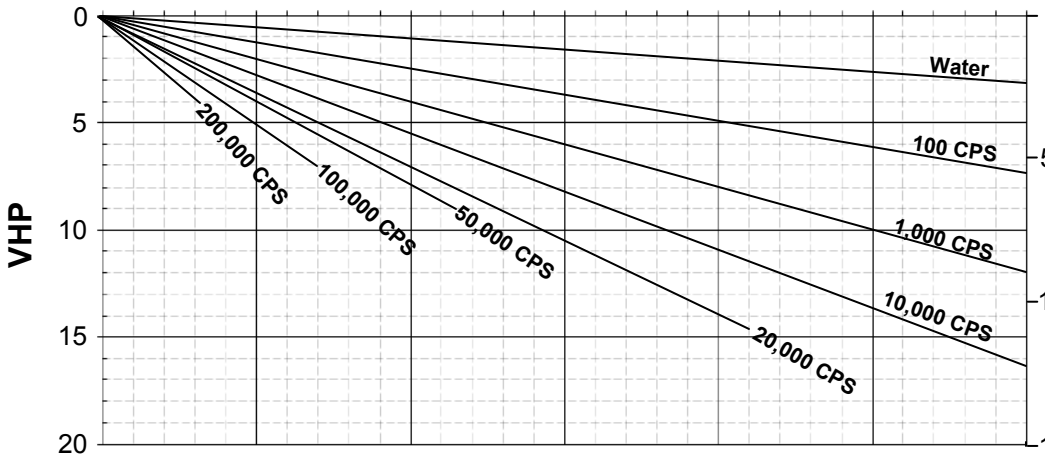
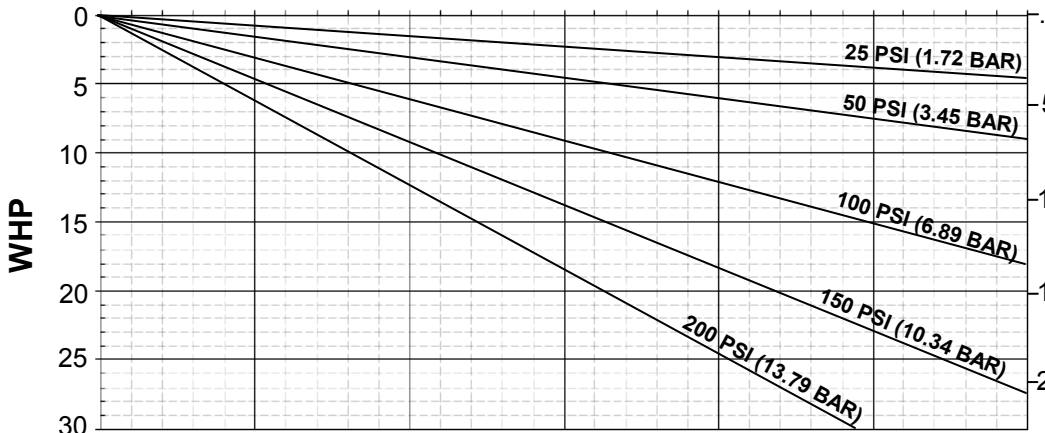
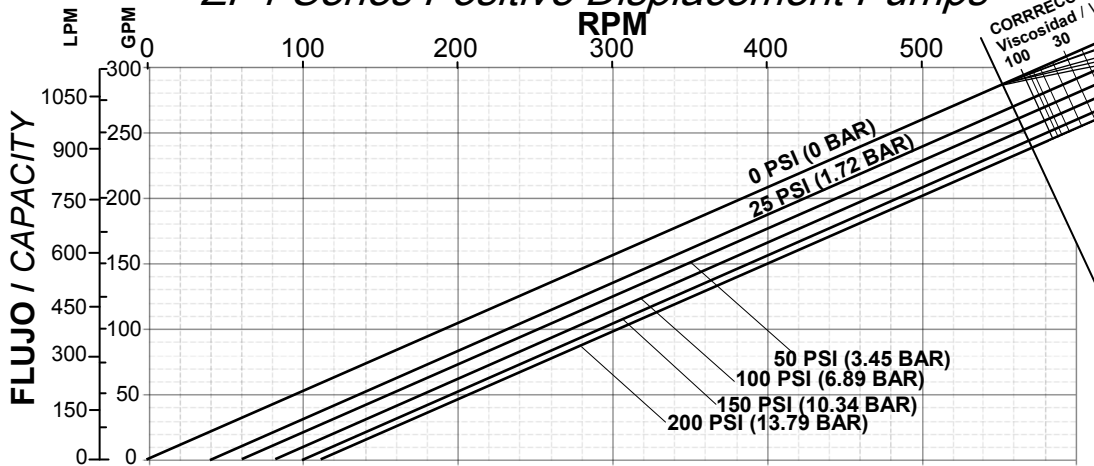

Modelo  
Model  
**ZP1-220**

Tolerancias estándar  
Standard Clearances

Conexiones estándar = 4.0"  
Standard Port Size = 4.0"

Desplazamiento  
Displacement  
0.522 Gal/Rev  
1.976 Lt/Rev

Velocidad máxima  
Max. Speed  
600 RPM

Presión máxima  
Max. Pressure  
200 PSI (13.78 BAR)

Rango de temperatura  
- 40° C a 149° C  
Temperature Range  
- 40° F to 300° F

Sujeto a cambios  
sin previo aviso  
Subject to change  
without notice

BHP = WHP + VHP  
BKW = WKW + VKW



Acceso "A" #103  
Fracc. Ind. Jurica  
Querétaro, Qro. México  
CP 76130  
+52 (442) 218 4570  
+52 (442) 103 3100  
Fax: +52 (442) 218 4577  
ventas@qpumps.com  
sales@qpumps.com  
www.qpumps.com

# Bombas de desplazamiento positivo ZP1

## ZP1 Series Positive Displacement Pumps

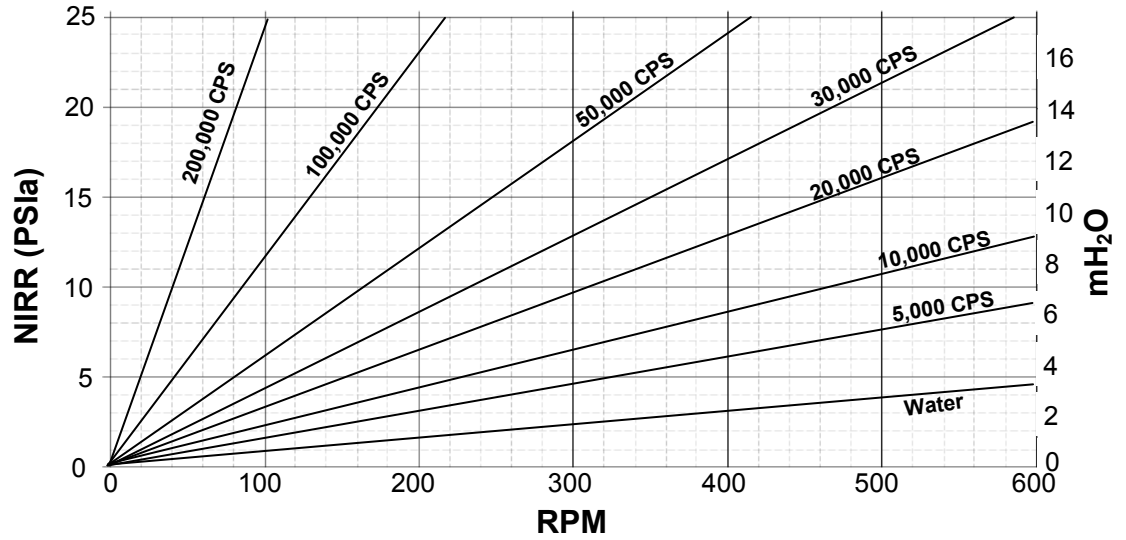
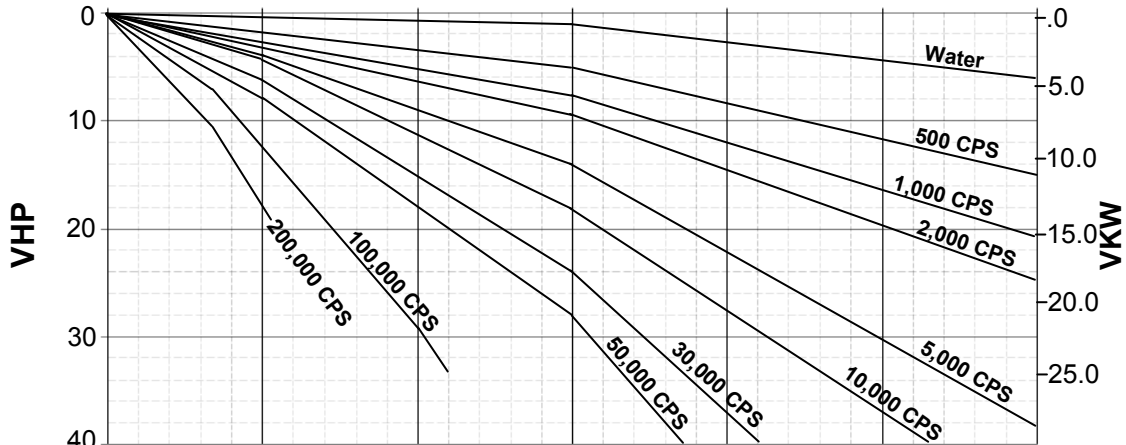
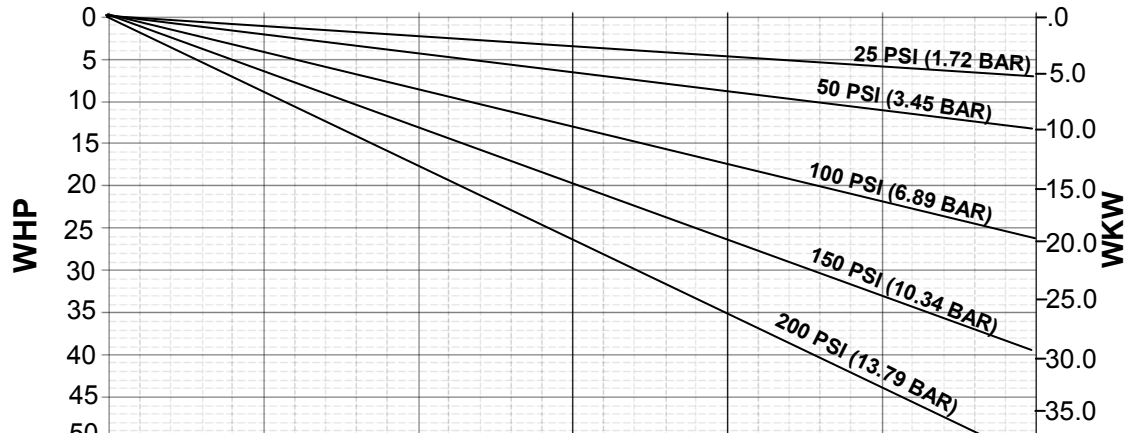
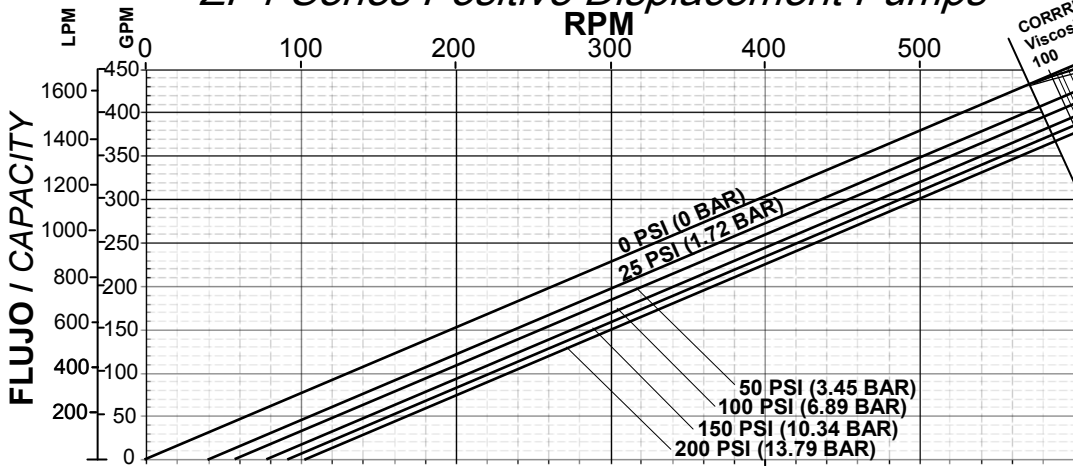

Modelo  
Model  
**ZP1-320**

Tolerancias estándar  
Standard Clearances

Conexiones estándar = 6.0"  
Standard Port Size = 6.0"

Desplazamiento  
Displacement  
0.754 Gal/Rev  
2.854 Lt/Rev

Velocidad máxima  
Max. Speed  
600 RPM

Presión máxima  
Max. Pressure  
200 PSI (13.78 BAR)

Rango de temperatura  
- 40° C a 149° C  
Temperature Range  
- 40° F to 300° F

Sujeto a cambios  
sin previo aviso  
Subject to change  
without notice

BHP = WHP + VHP  
BKW = WKW + VKW



Acceso "A" #103  
Fracc. Ind. Jurica  
Querétaro, Qro. México  
CP 76130  
+52 (442) 218 4570  
+52 (442) 103 3100  
Fax: +52 (442) 218 4577  
ventas@qpumps.com  
sales@qpumps.com  
www.qpumps.com



# Bombas de desplazamiento positivo ZP2

## ZP2 Series Positive Displacement Pumps

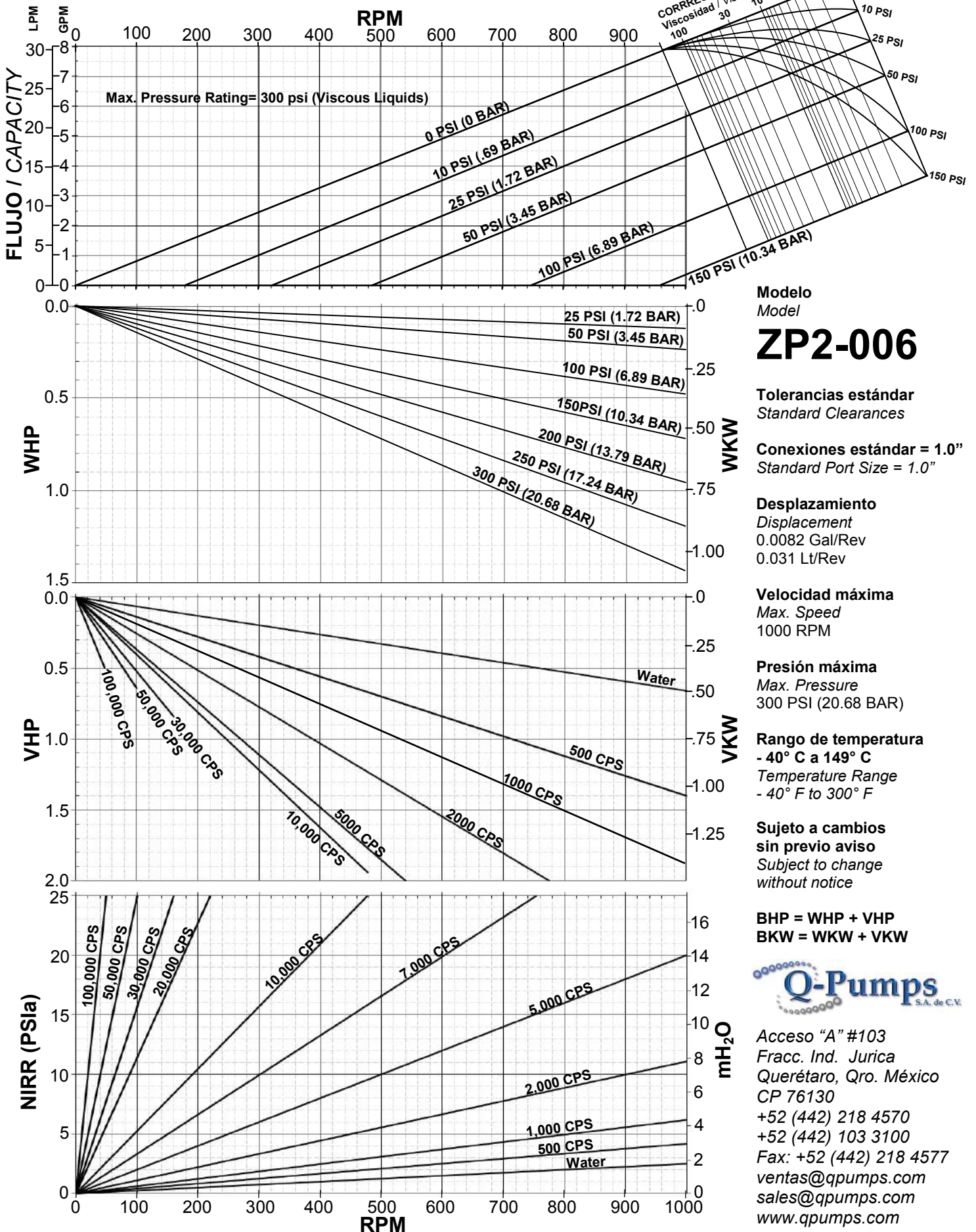

Max. Pressure Rating= 300 psi (Viscous Liquids)

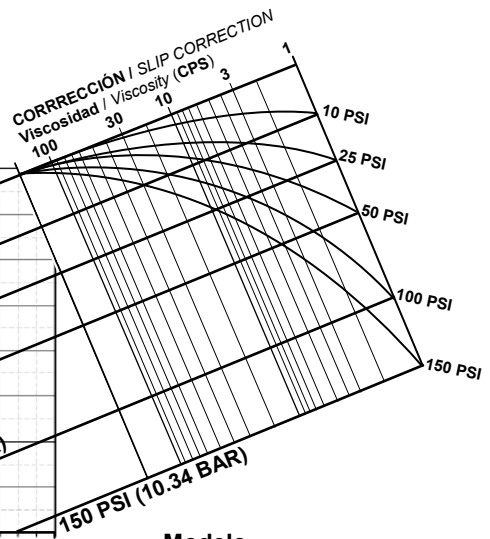

Modelo  
 Model  
**ZP2-006**

Tolerancias estándar  
 Standard Clearances

Conexiones estándar = 1.0"  
 Standard Port Size = 1.0"

Desplazamiento  
 Displacement  
 0.0082 Gal/Rev  
 0.031 Lt/Rev

Velocidad máxima  
 Max. Speed  
 1000 RPM

Presión máxima  
 Max. Pressure  
 300 PSI (20.68 BAR)

Rango de temperatura  
 - 40° C a 149° C  
 Temperature Range  
 - 40° F to 300° F

Sujeto a cambios  
 sin previo aviso  
 Subject to change  
 without notice

BHP = WHP + VHP  
 BKW = WKW + VKW



Acceso "A" #103  
 Fracc. Ind. Jurica  
 Querétaro, Qro. México  
 CP 76130  
 +52 (442) 218 4570  
 +52 (442) 103 3100  
 Fax: +52 (442) 218 4577  
 ventas@qpumps.com  
 sales@qpumps.com  
 www.qpumps.com

# Bombas de desplazamiento positivo ZP2

## ZP2 Series Positive Displacement Pumps

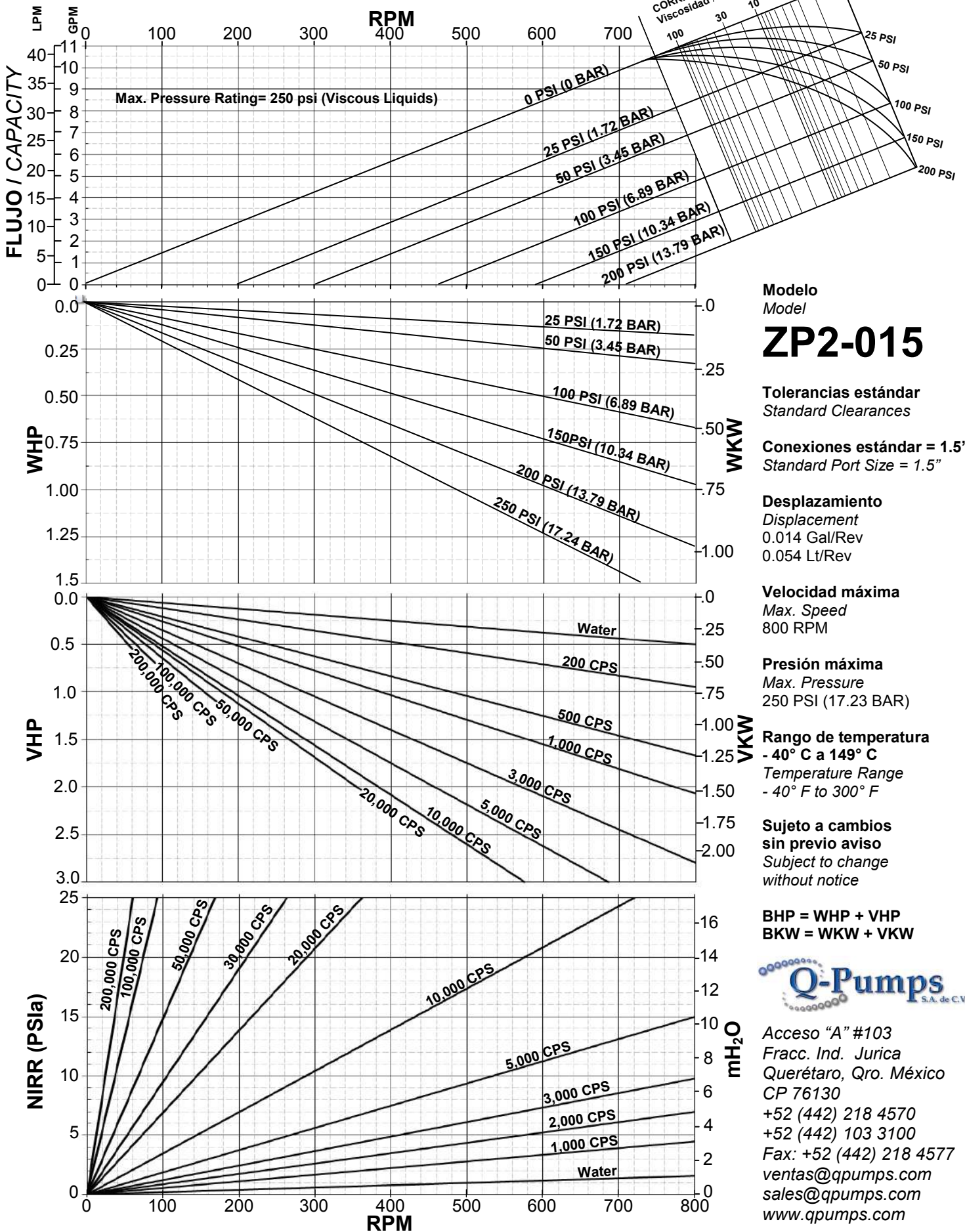

Modelo  
Model  
**ZP2-015**

Tolerancias estándar  
Standard Clearances

Conexiones estándar = 1.5"  
Standard Port Size = 1.5"

Desplazamiento  
Displacement  
0.014 Gal/Rev  
0.054 Lt/Rev

Velocidad máxima  
Max. Speed  
800 RPM

Presión máxima  
Max. Pressure  
250 PSI (17.23 BAR)

Rango de temperatura  
- 40° C a 149° C  
Temperature Range  
- 40° F to 300° F

Sujeto a cambios  
sin previo aviso  
Subject to change  
without notice

BHP = WHP + VHP  
BKW = WKW + VKW



Acceso "A" #103  
Frac. Ind. Jurica  
Querétaro, Qro. México  
CP 76130  
+52 (442) 218 4570  
+52 (442) 103 3100  
Fax: +52 (442) 218 4577  
ventas@qpumps.com  
sales@qpumps.com  
www.qpumps.com

# Bombas de desplazamiento positivo ZP2

## ZP2 Series Positive Displacement Pumps

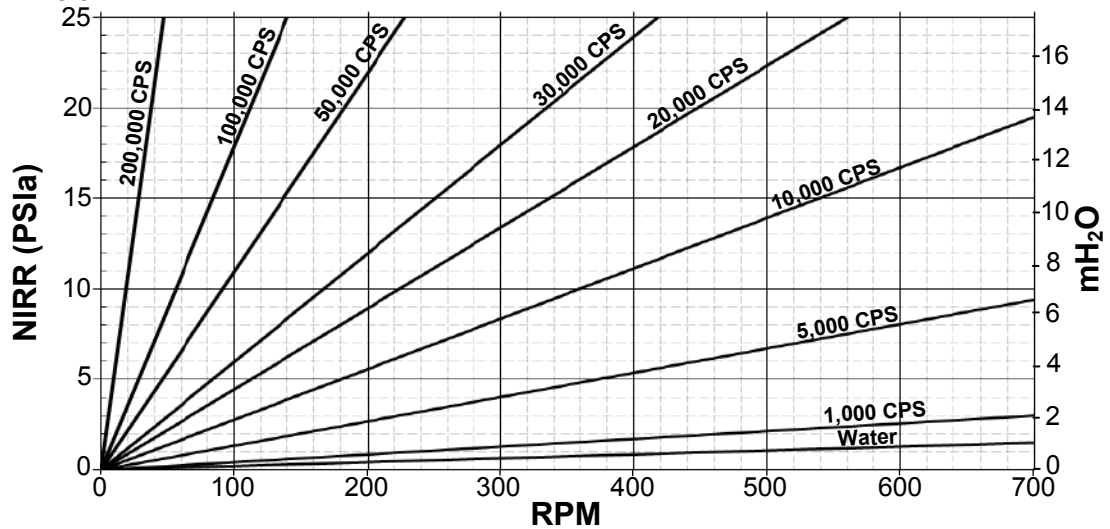
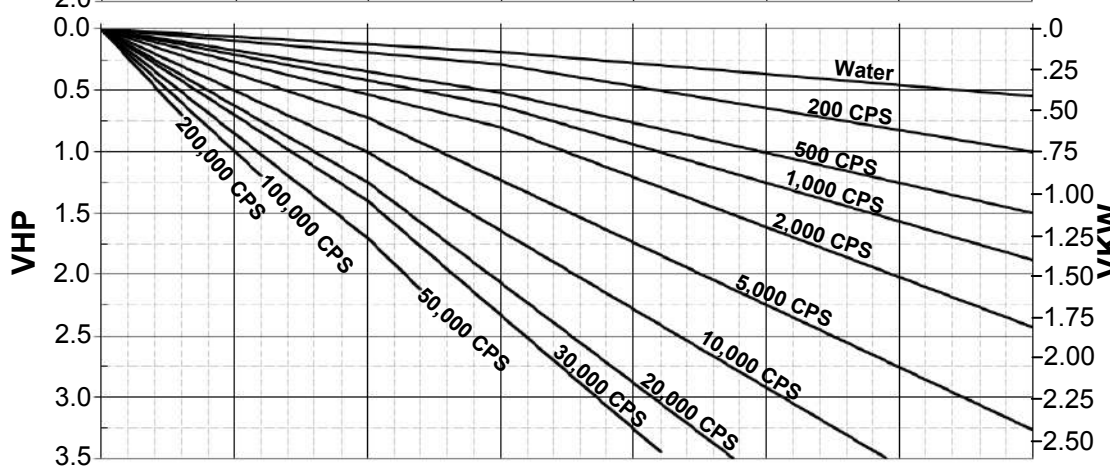
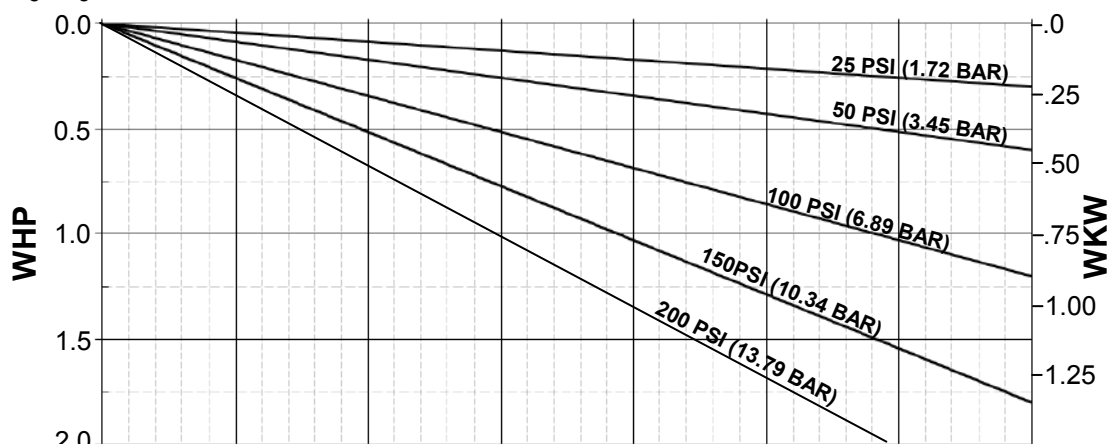
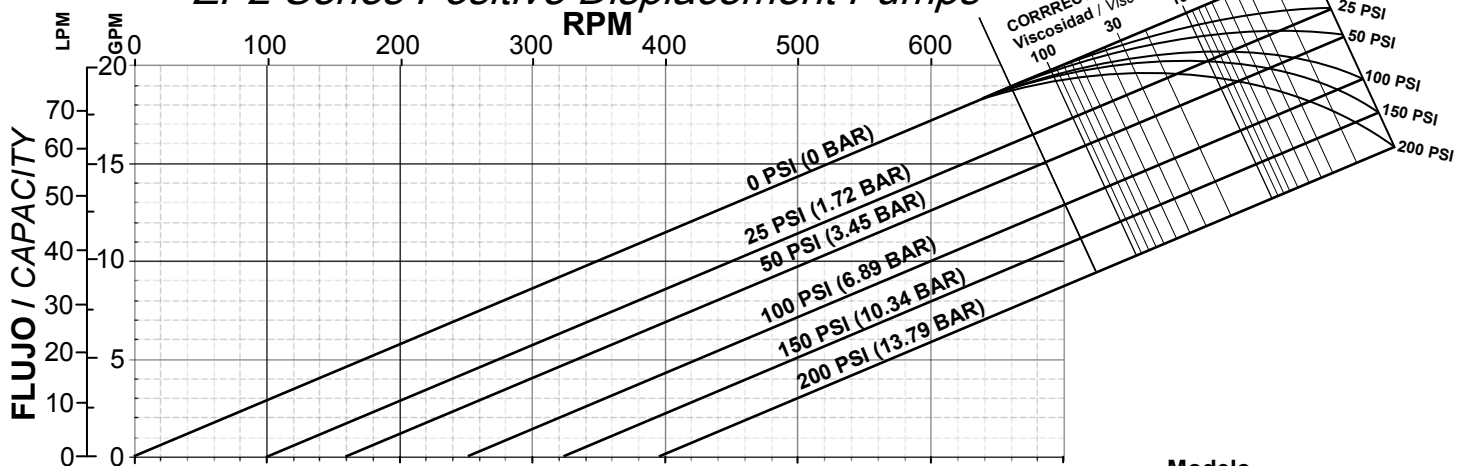

**Modelo**  
Model  
**ZP2-018**

**Tolerancias estándar**  
Standard Clearances

**Conexiones estándar = 1.5"**  
Standard Port Size = 1.5"

**Desplazamiento**  
Displacement  
0.029 Gal/Rev  
0.108 Lt/Rev

**Velocidad máxima**  
Max. Speed  
700 RPM

**Presión máxima**  
Max. Pressure  
200 PSI (13.78 BAR)

**Rango de temperatura**  
- 40° C a 149° C  
Temperature Range  
- 40° F to 300° F

**Sujeto a cambios sin previo aviso**  
Subject to change without notice

**BHP = WHP + VHP**  
**BKW = WKW + VKW**



Acceso "A" #103  
Fracc. Ind. Jurica  
Querétaro, Qro. México  
CP 76130  
+52 (442) 218 4570  
+52 (442) 103 3100  
Fax: +52 (442) 218 4577  
ventas@qpumps.com  
sales@qpumps.com  
www.qpumps.com

# Bombas de desplazamiento positivo ZP2

## ZP2 Series Positive Displacement Pumps

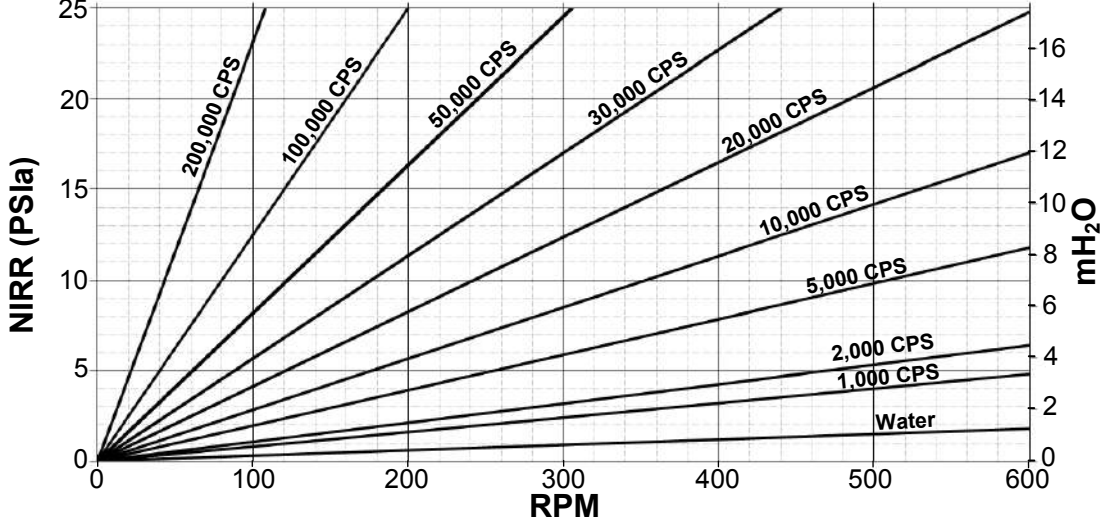
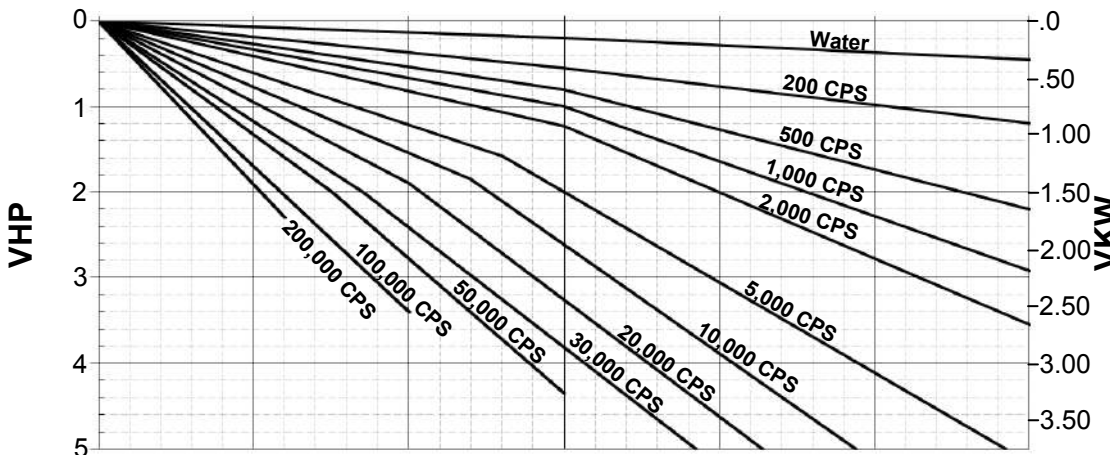
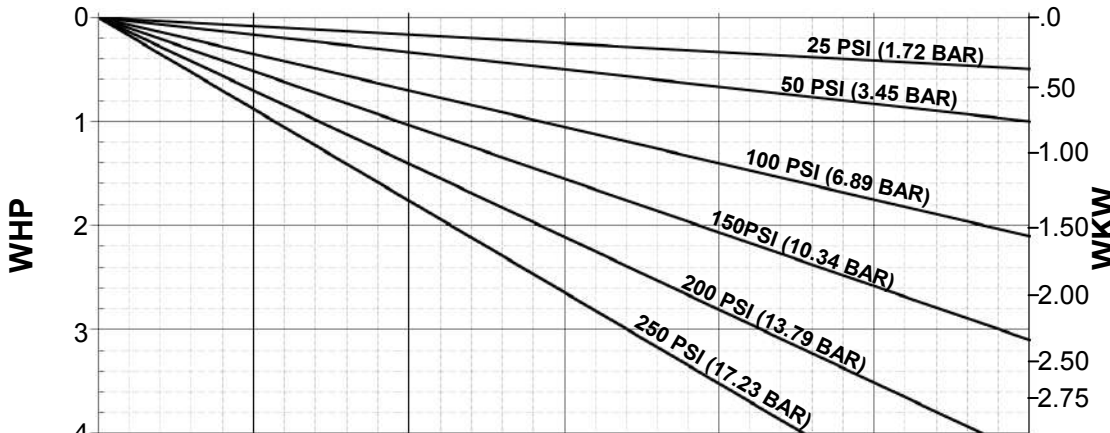
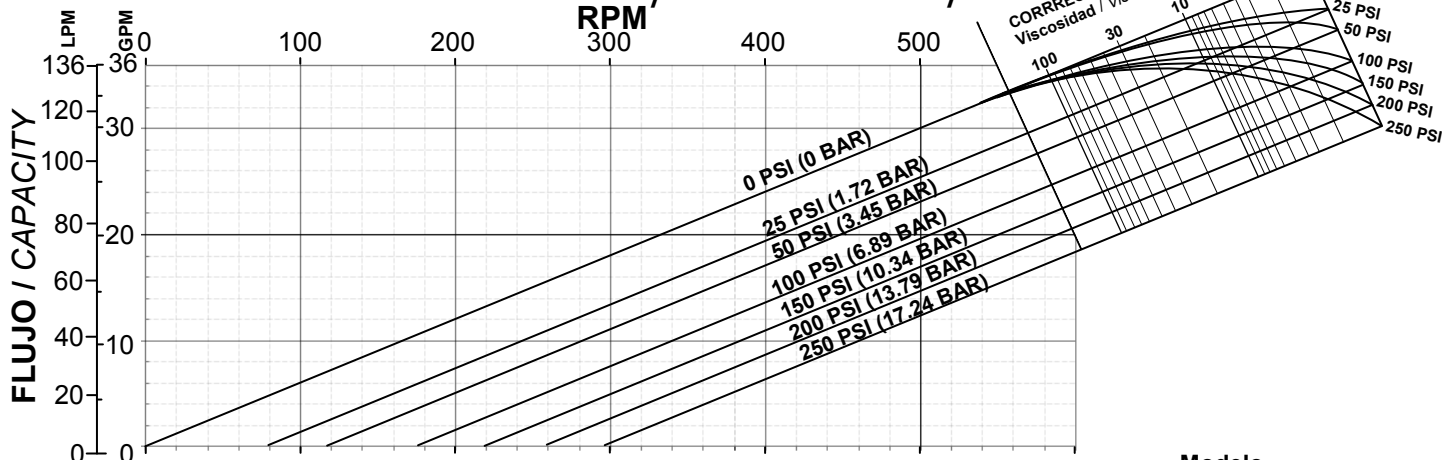

Modelo  
Model  
**ZP2-030**

Tolerancias estándar  
Standard Clearances

Conexiones estándar = 1.5"  
Standard Port Size = 1.5"

Desplazamiento  
Displacement  
0.060 Gal/Rev  
0.227 Lt/Rev

Velocidad máxima  
Max. Speed  
600 RPM

Presión máxima  
Max. Pressure  
250 PSI (17.23 BAR)

Rango de temperatura  
- 40° C a 149° C  
Temperature Range  
- 40° F to 300° F

Sujeto a cambios  
sin previo aviso  
Subject to change  
without notice

BHP = WHP + VHP  
BKW = WKW + VKW



Acceso "A" #103  
Fracc. Ind. Jurica  
Querétaro, Qro. México  
CP 76130  
+52 (442) 218 4570  
+52 (442) 103 3100  
Fax: +52 (442) 218 4577  
ventas@qpumps.com  
sales@qpumps.com  
www.qpumps.com

# Bombas de desplazamiento positivo ZP2

## ZP2 Series Positive Displacement Pumps

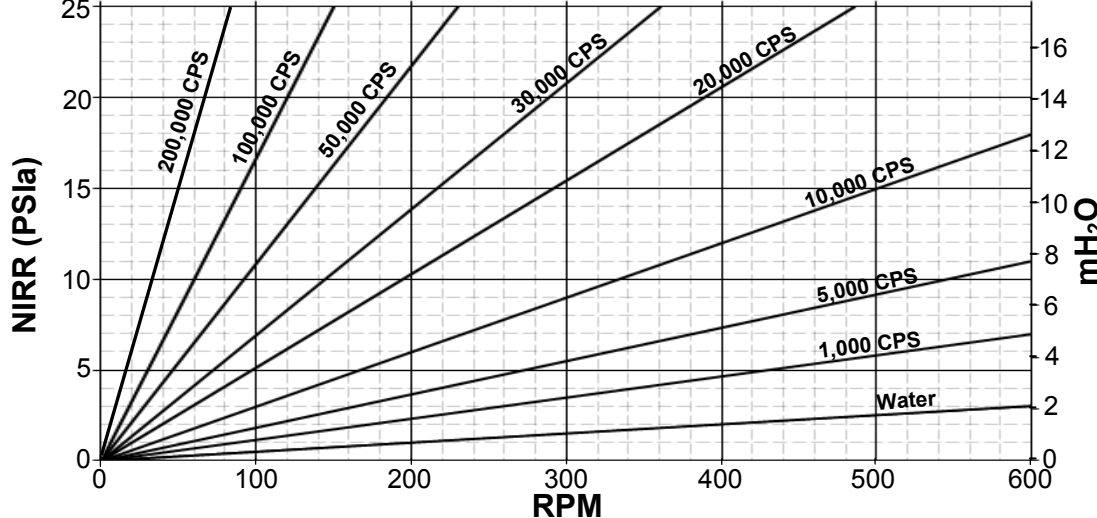
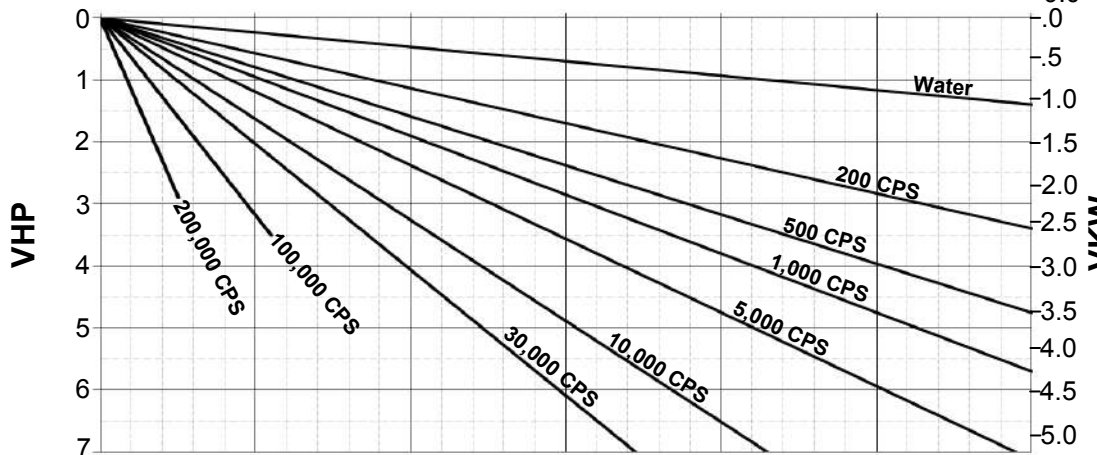
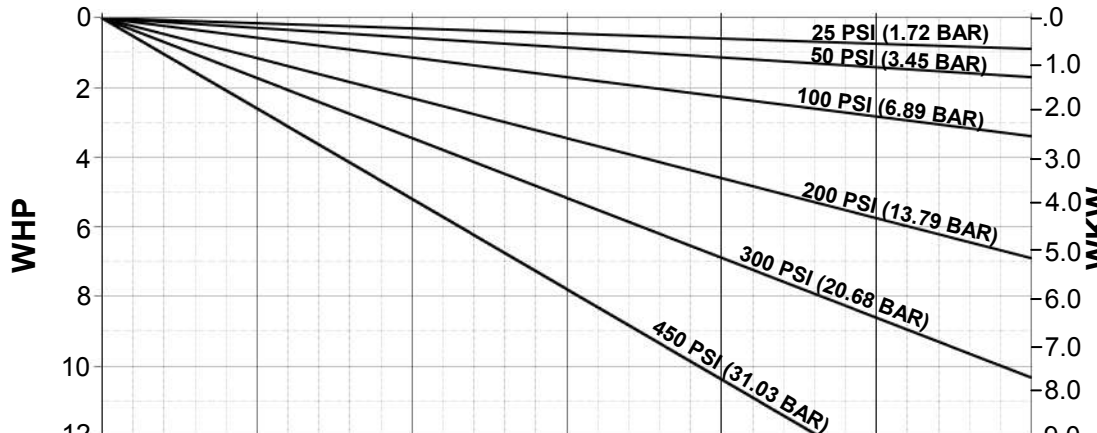
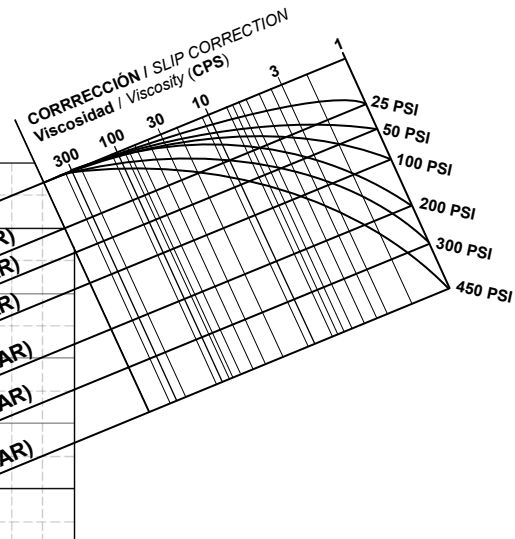
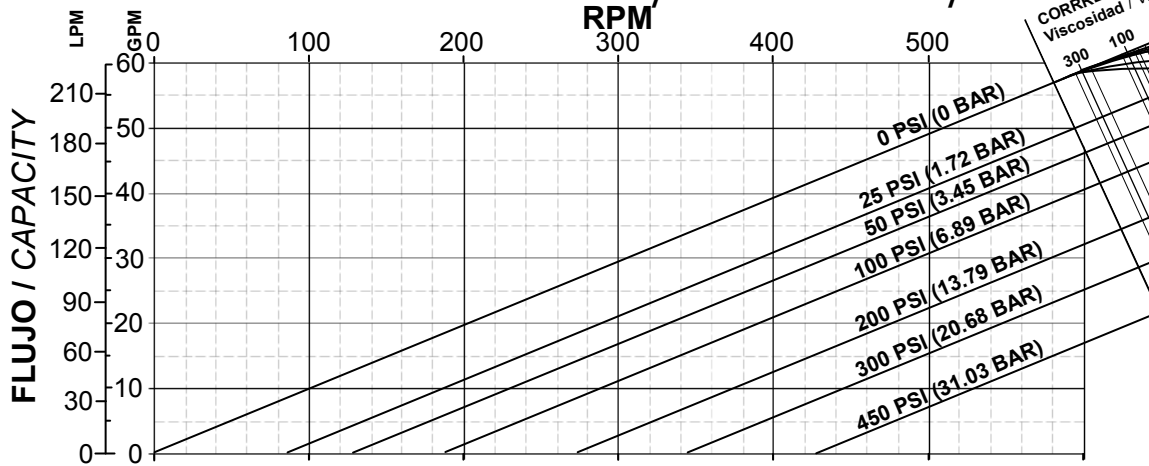

Modelo  
Model  
**ZP2-045**

Tolerancias estándar  
Standard Clearances

Conexiones estándar = 2.0"  
Standard Port Size = 2.0"

Desplazamiento  
Displacement  
0.098 Gal/Rev  
0.371 Lt/Rev

Velocidad máxima  
Max. Speed  
600 RPM

Presión máxima  
Max. Pressure  
450 PSI (31.02 BAR)

Rango de temperatura  
- 40° C a 149° C  
Temperature Range  
- 40° F to 300° F

Sujeto a cambios  
sin previo aviso  
Subject to change  
without notice

BHP = WHP + VHP  
BKW = WKW + VKW



Acceso "A" #103  
Fracc. Ind. Jurica  
Querétaro, Qro. México  
CP 76130  
+52 (442) 218 4570  
+52 (442) 103 3100  
Fax: +52 (442) 218 4577  
ventas@qpumps.com  
sales@qpumps.com  
www.qpumps.com

# Bombas de desplazamiento positivo ZP2

## ZP2 Series Positive Displacement Pumps

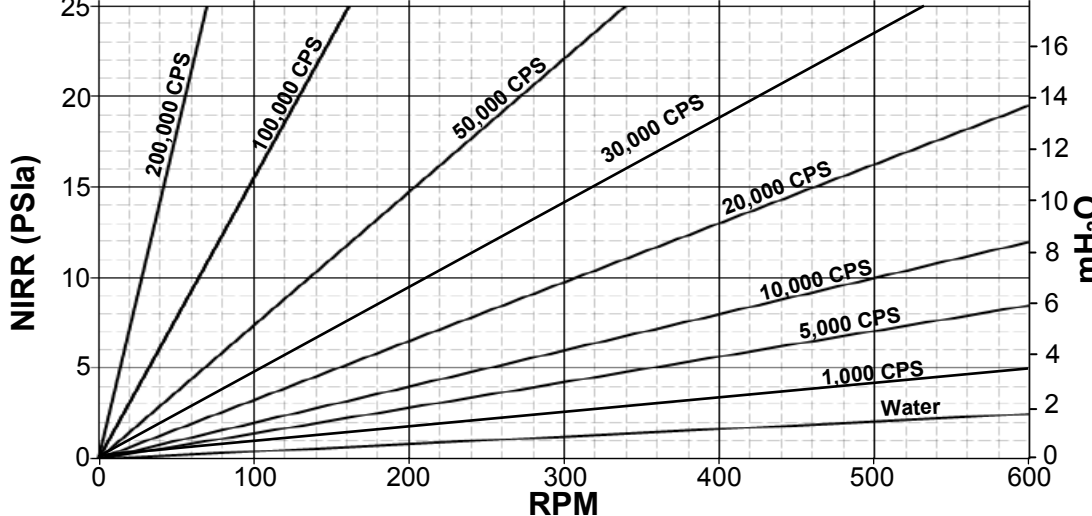
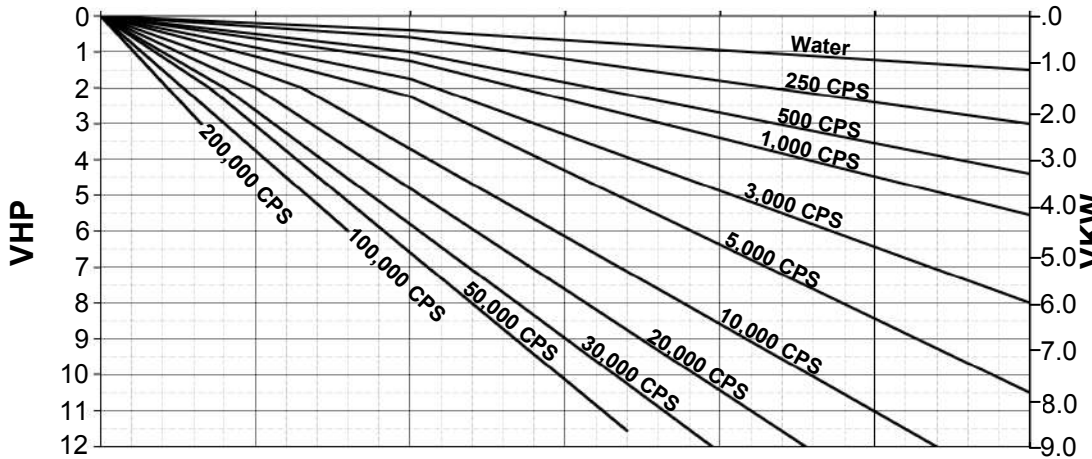
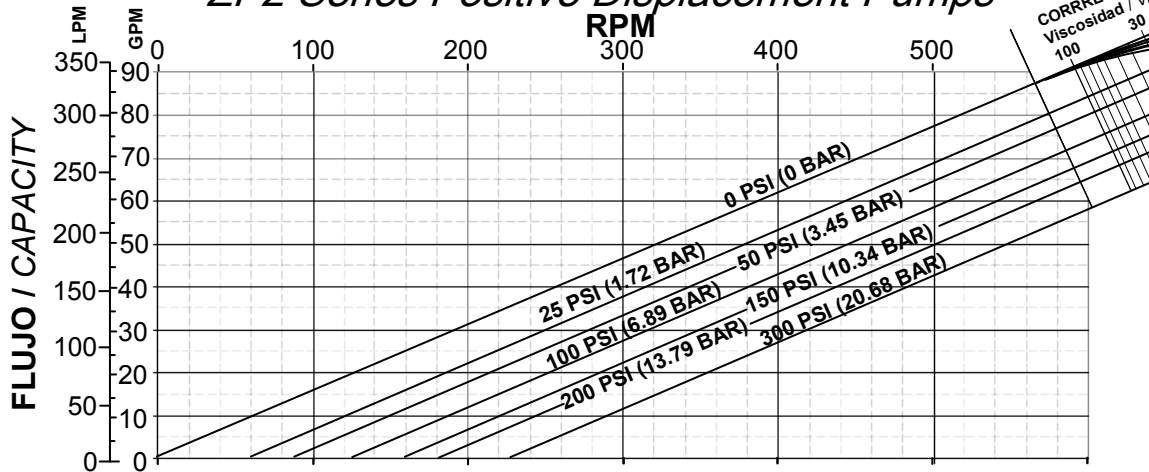

**Modelo**  
Model

# ZP2-060

**Tolerancias estándar**  
Standard Clearances

**Conexiones estándar = 2.5"**  
Standard Port Size = 2.5"

**Desplazamiento**  
Displacement  
0.153 Gal/Rev  
0.579 Lt/Rev

**Velocidad máxima**  
Max. Speed  
600 RPM

**Presión máxima**  
Max. Pressure  
300 PSI (20.68 BAR)

**Rango de temperatura**  
- 40° C a 149° C  
Temperature Range  
- 40° F to 300° F

**Sujeto a cambios sin previo aviso**  
Subject to change without notice

**BHP = WHP + VHP**  
**BKW = WKW + VKW**



Acceso "A" #103  
Fracc. Ind. Jurica  
Querétaro, Qro. México  
CP 76130  
+52 (442) 218 4570  
+52 (442) 103 3100  
Fax: +52 (442) 218 4577  
ventas@qpumps.com  
sales@qpumps.com  
www.qpumps.com

# Bombas de desplazamiento positivo ZP2

## ZP2 Series Positive Displacement Pumps

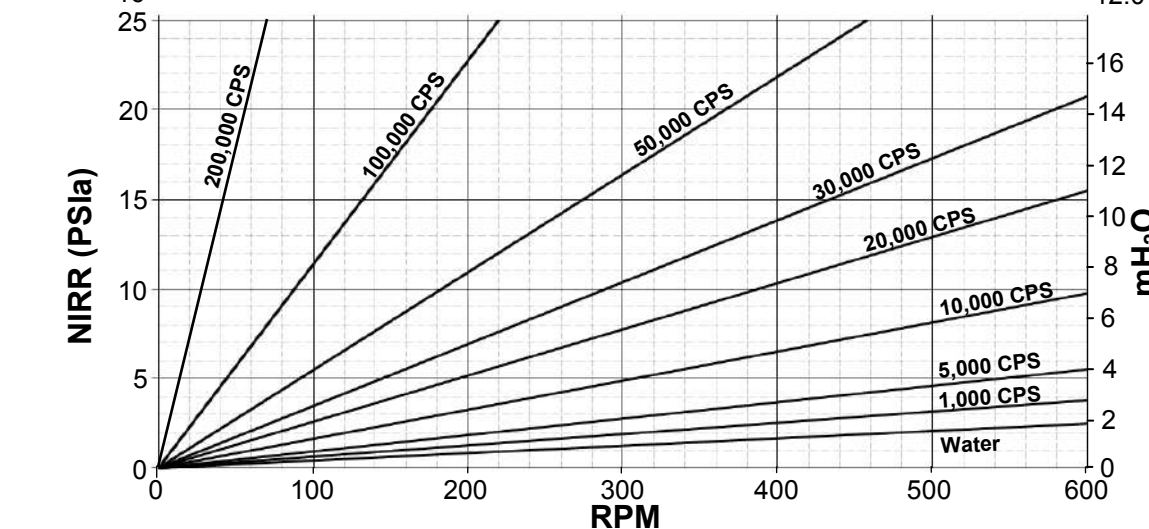
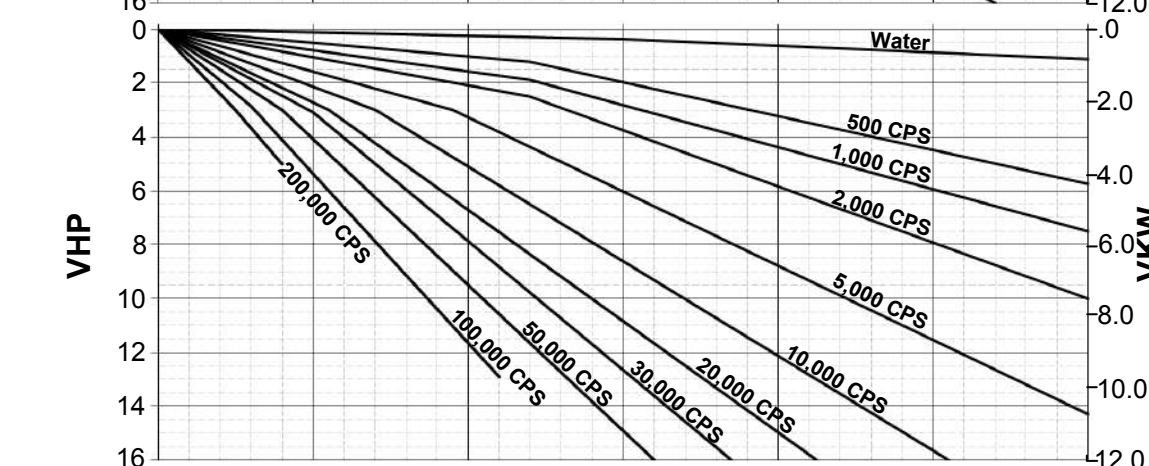
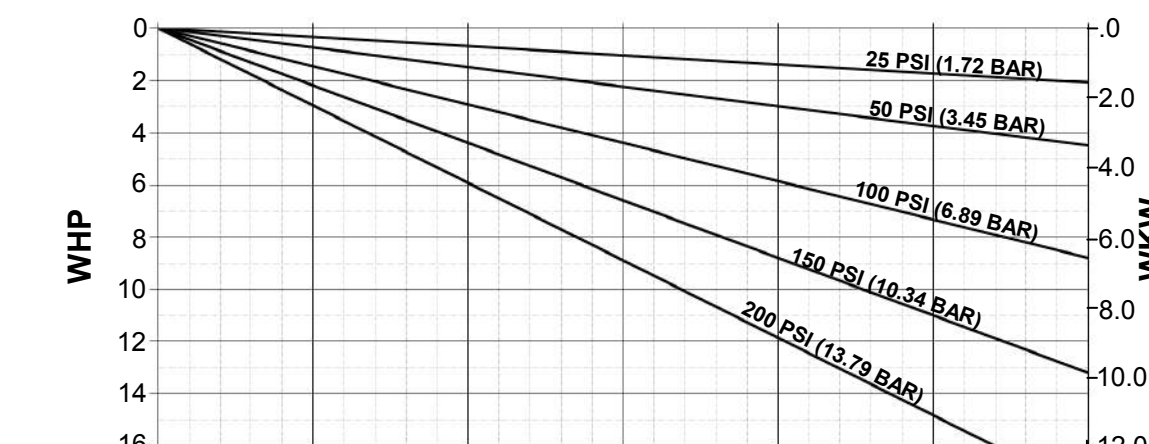
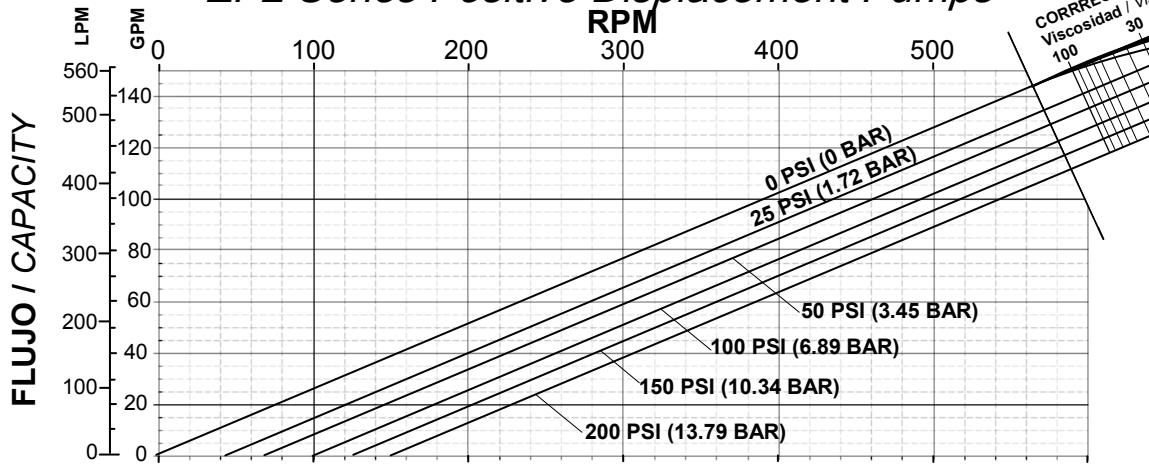

Modelo  
Model

# ZP2-130

Tolerancias estándar  
Standard Clearances

Conexiones estándar = 3.0"  
Standard Port Size = 3.0"

Desplazamiento  
Displacement  
0.253 Gal/Rev  
0.958 Lt/Rev

Velocidad máxima  
Max. Speed  
600 RPM

Presión máxima  
Max. Pressure  
200 PSI (13.78 BAR)

Rango de temperatura  
- 40° C a 149° C  
Temperature Range  
- 40° F to 300° F

Sujeto a cambios  
sin previo aviso  
Subject to change  
without notice

BHP = WHP + VHP  
BKW = WKW + VKW



Acceso "A" #103  
Fracc. Ind. Jurica  
Querétaro, Qro. México  
CP 76130  
+52 (442) 218 4570  
+52 (442) 103 3100  
Fax: +52 (442) 218 4577  
ventas@qpumps.com  
sales@qpumps.com  
www.qpumps.com

# Bombas de desplazamiento positivo ZP2

## ZP2 Series Positive Displacement Pumps

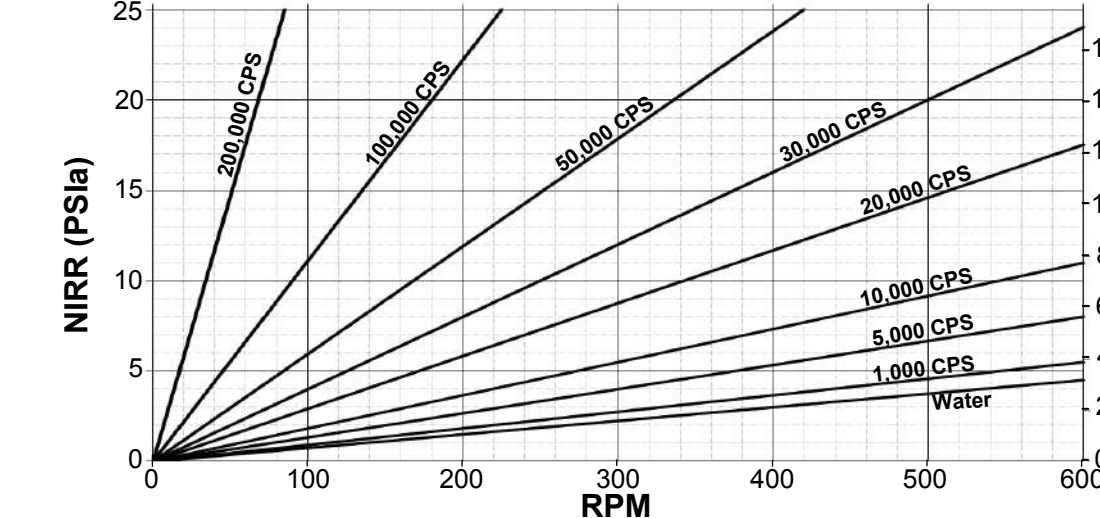
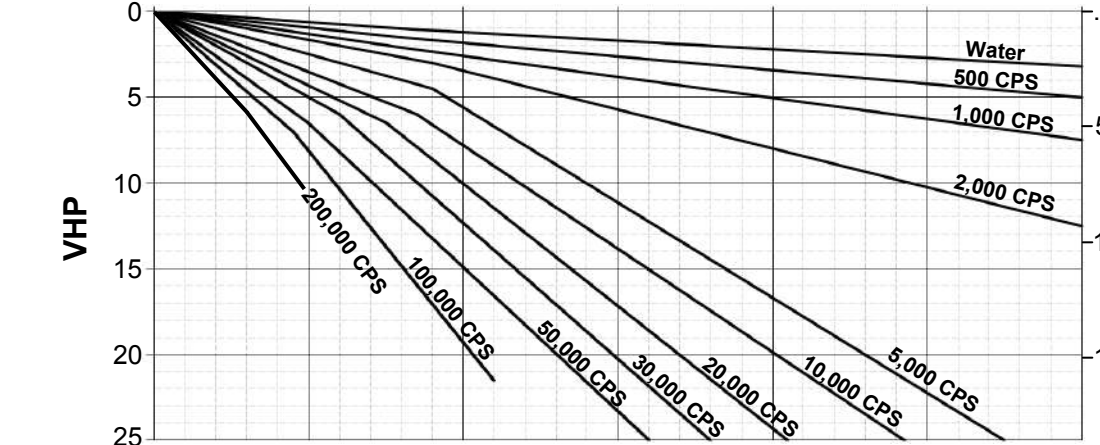
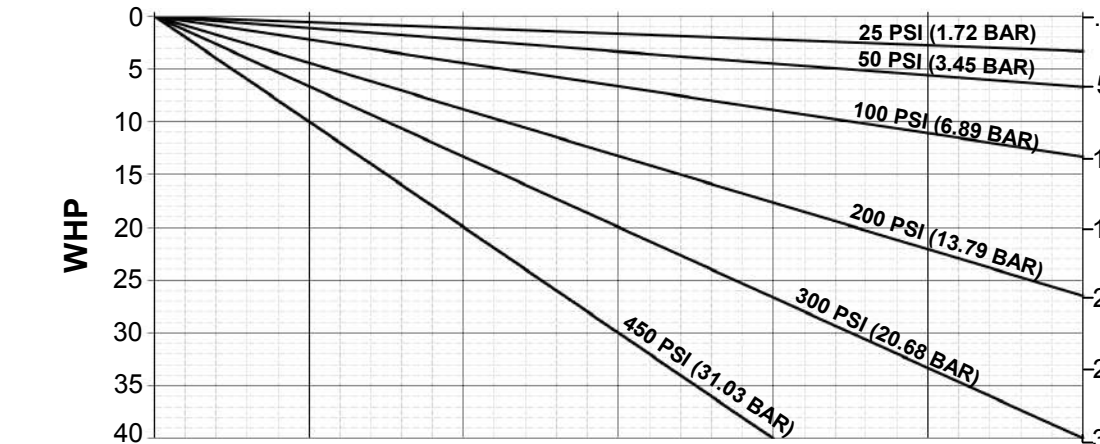
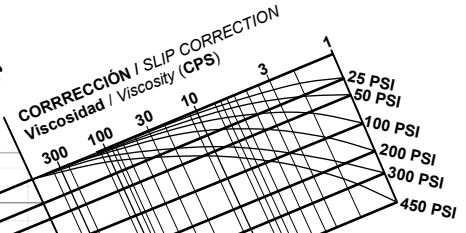
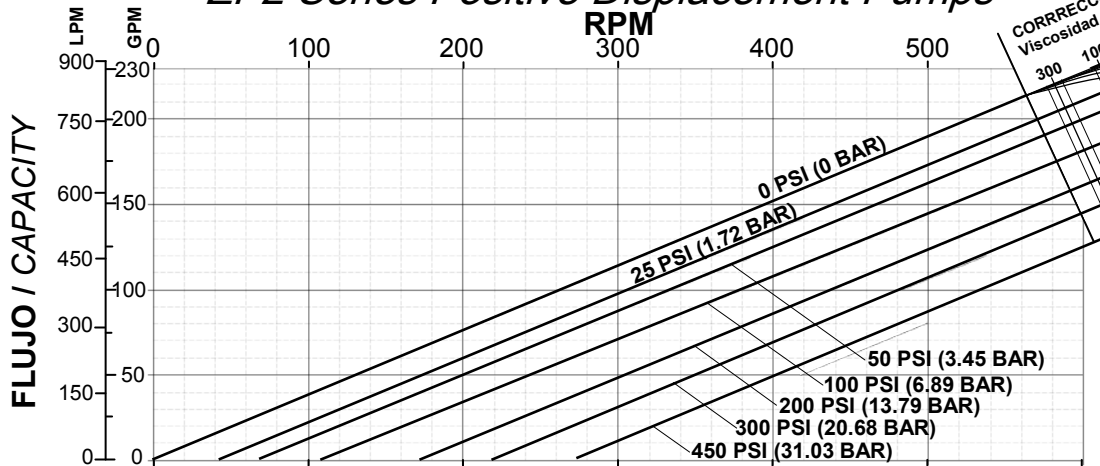

Modelo  
Model

### ZP2-180

Tolerancias estándar  
Standard Clearances

Conexiones estándar = 3.0"  
Standard Port Size = 3.0"

Desplazamiento  
Displacement  
0.380 Gal/Rev  
1.438 Lt/Rev

Velocidad máxima  
Max. Speed  
600 RPM

Presión máxima  
Max. Pressure  
450 PSI (31.02 BAR)

Rango de temperatura  
- 40° C a 149° C  
Temperature Range  
- 40° F to 300° F

Sujeto a cambios  
sin previo aviso  
Subject to change  
without notice

BHP = WHP + VHP  
BKW = WKW + VKW



Acceso "A" #103  
Fracc. Ind. Jurica  
Querétaro, Qro. México  
CP 76130  
+52 (442) 218 4570  
+52 (442) 103 3100  
Fax: +52 (442) 218 4577  
ventas@qpumps.com  
sales@qpumps.com  
www.qpumps.com



# Bombas de desplazamiento positivo ZP2

## ZP2 Series Positive Displacement Pumps

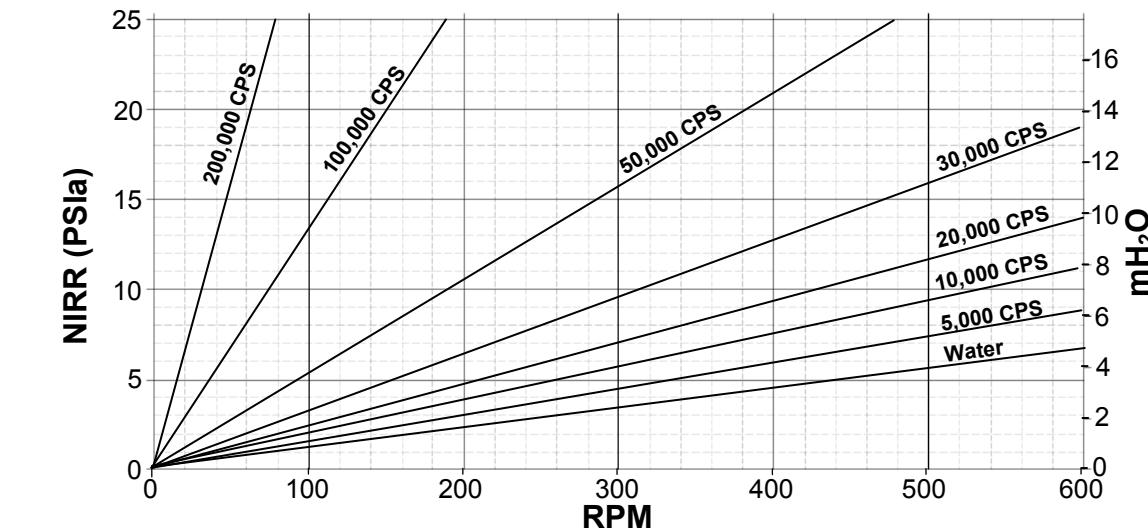
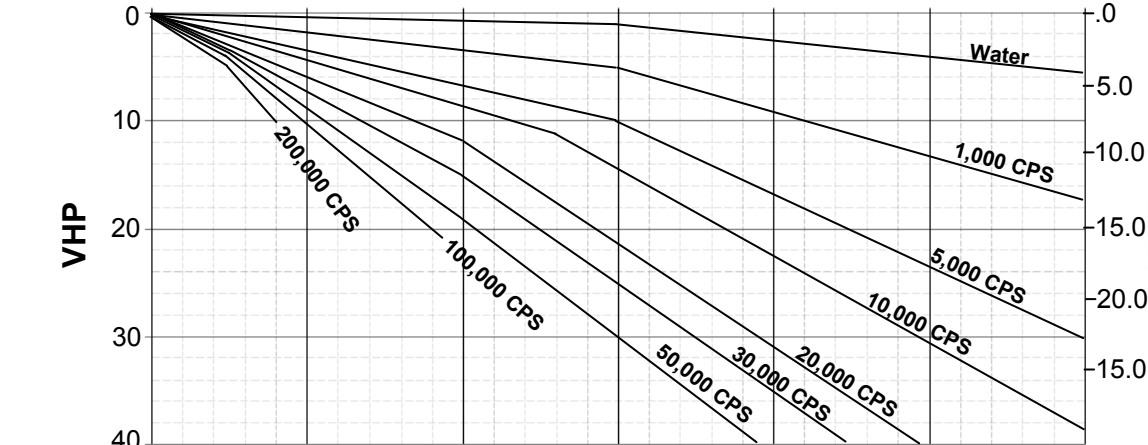
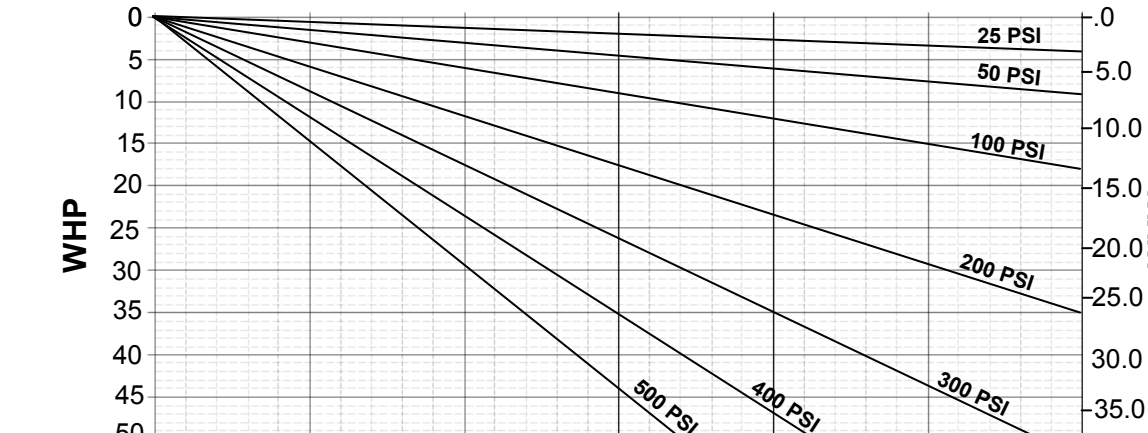
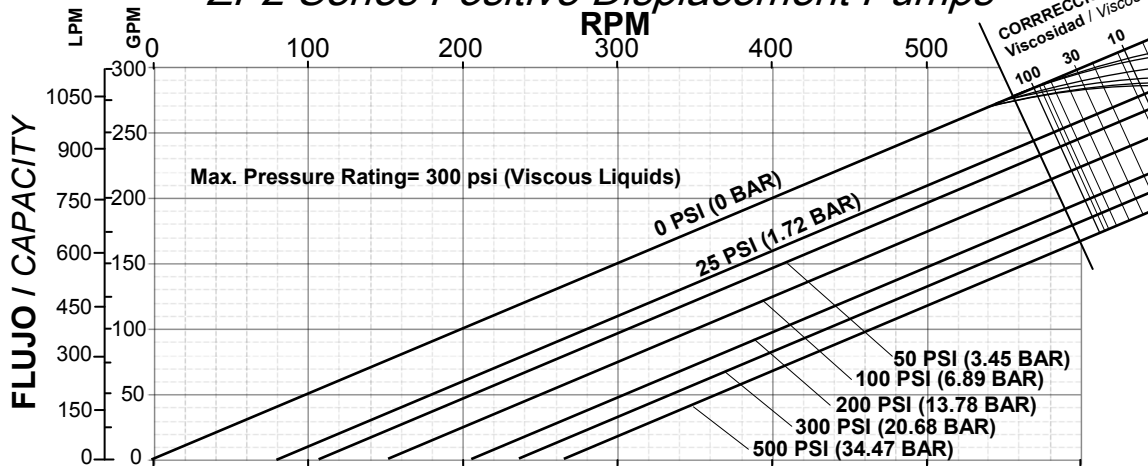

Modelo  
Model

# ZP2-210

Tolerancias estándar  
Standard Clearances

Conexiones estándar = 4.0"  
Standard Port Size = 4.0"

Desplazamiento  
Displacement  
0.502 Gal/Rev  
1.900 Lt/Rev

Velocidad máxima  
Max. Speed  
600 RPM

Presión máxima  
Max. Pressure  
300 PSI (20.68 BAR)

Rango de temperatura  
- 40° C a 149° C  
Temperature Range  
- 40° F to 300° F

Sujeto a cambios  
sin previo aviso  
Subject to change  
without notice

BHP = WHP + VHP  
BKW = VKW + VKW



Acceso "A" #103  
Fracc. Ind. Jurica  
Querétaro, Qro. México  
CP 76130  
+52 (442) 218 4570  
+52 (442) 103 3100  
Fax: +52 (442) 218 4577  
ventas@qpumps.com  
sales@qpumps.com  
www.qpumps.com

# Bombas de desplazamiento positivo ZP2

## ZP2 Series Positive Displacement Pumps

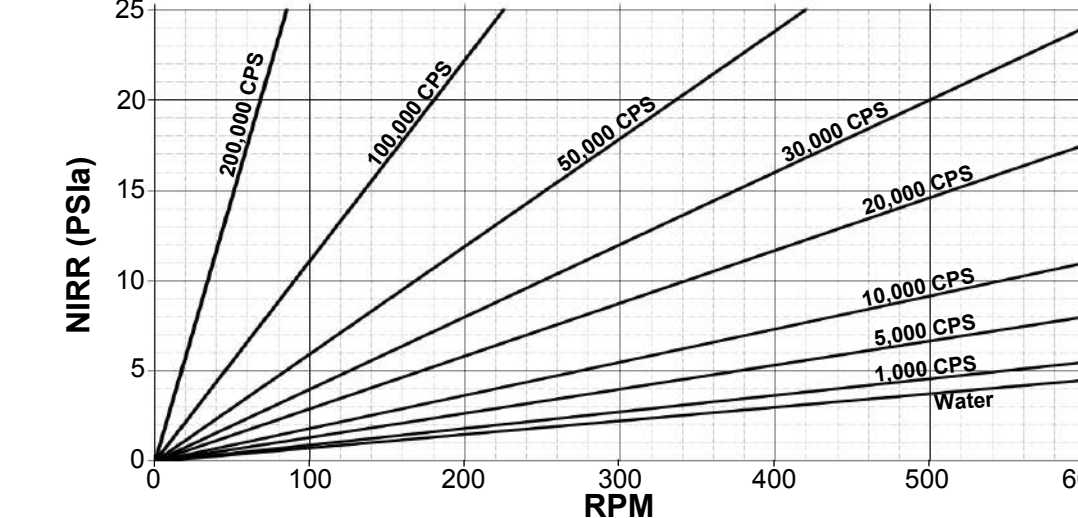
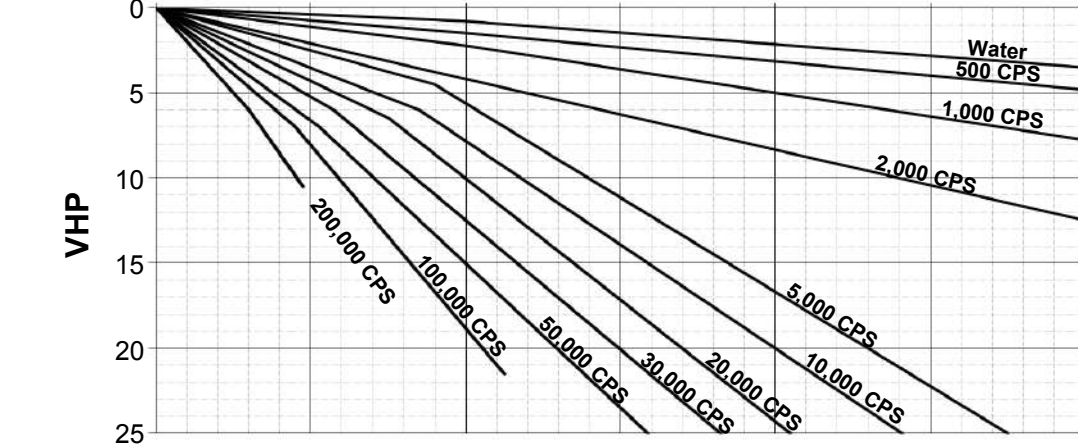
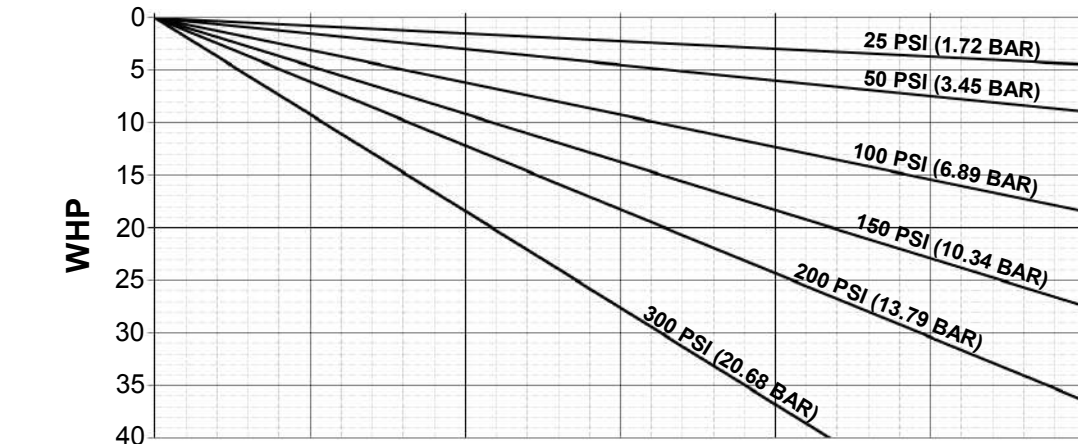
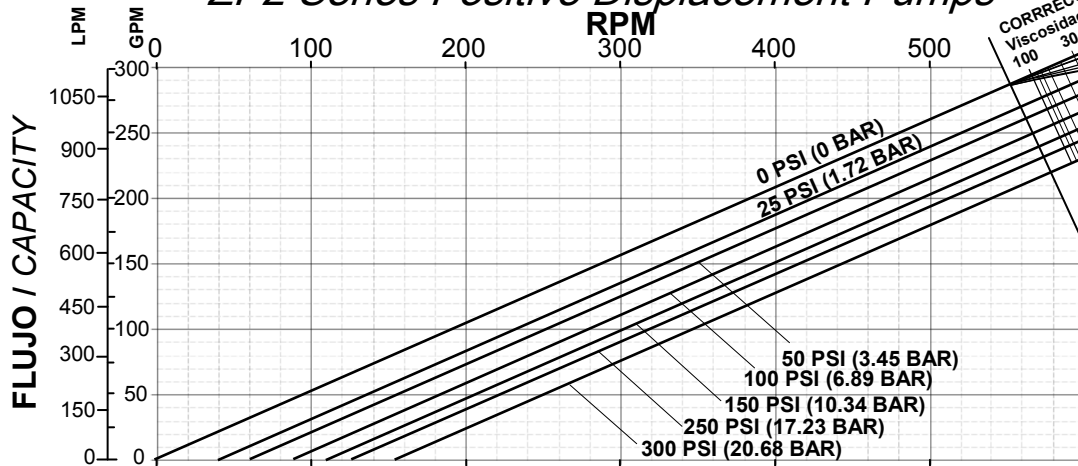

**Modelo**  
Model

# ZP2-220

**Tolerancias estándar**  
Standard Clearances

**Conexiones estándar = 4.0"**  
Standard Port Size = 4.0"

**Desplazamiento**  
Displacement  
0.521 Gal/Rev  
1.972 Lt/Rev

**Velocidad máxima**  
Max. Speed  
600 RPM

**Presión máxima**  
Max. Pressure  
300 PSI (20.68 BAR)

**Rango de temperatura**  
- 40° C a 149° C  
Temperature Range  
- 40° F to 300° F

**Sujeto a cambios sin previo aviso**  
Subject to change without notice

**BHP = WHP + VHP**  
**BKW = WKW + VKW**



Acceso "A" #103  
Fracc. Ind. Jurica  
Querétaro, Qro. México  
CP 76130  
+52 (442) 218 4570  
+52 (442) 103 3100  
Fax: +52 (442) 218 4577  
ventas@qpumps.com  
sales@qpumps.com  
www.qpumps.com

# Bombas de desplazamiento positivo ZP2

## ZP2 Series Positive Displacement Pumps

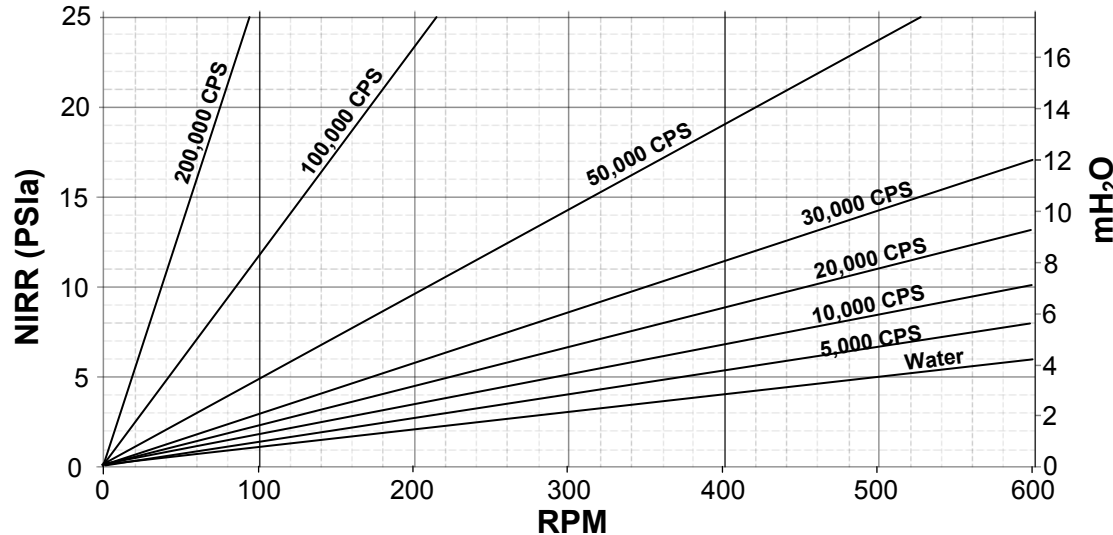
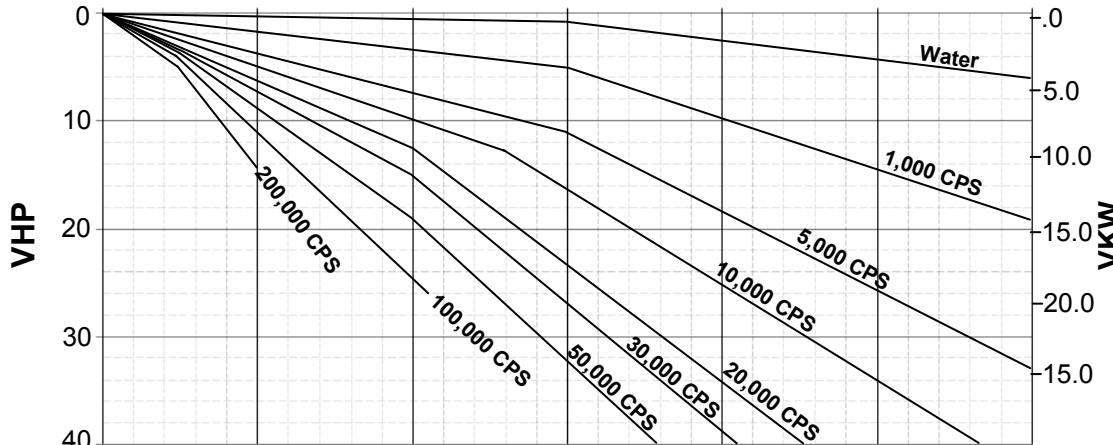
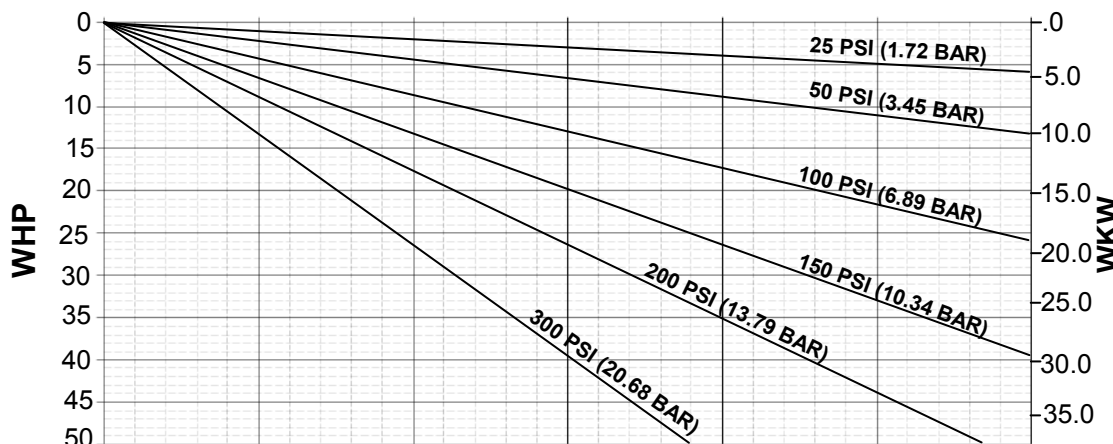
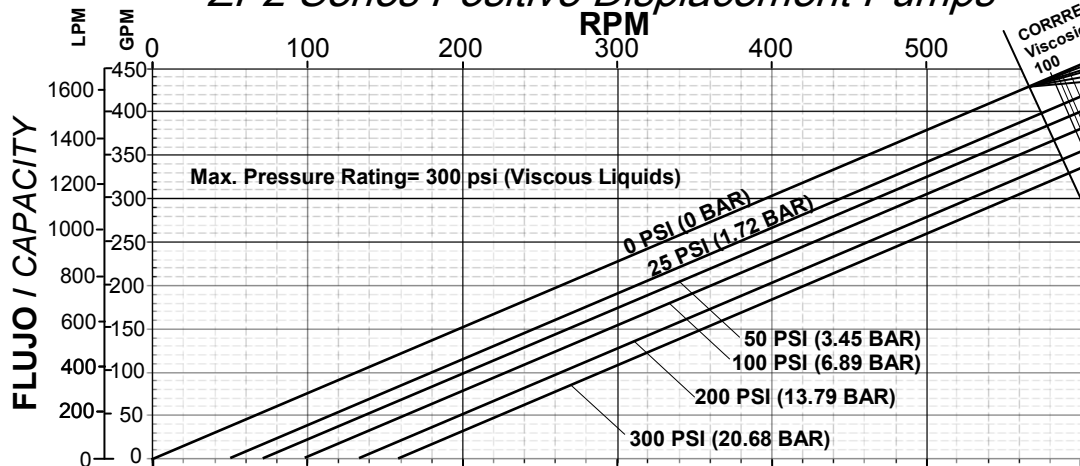

Modelo  
Model  
**ZP2-320**

Tolerancias estándar  
Standard Clearances

Conexiones estándar = 6.0"  
Standard Port Size = 6.0"

Desplazamiento  
Displacement  
0.720 Gal/Rev  
2.725 Lt/Rev

Velocidad máxima  
Max. Speed  
600 RPM

Presión máxima  
Max. Pressure  
300 PSI (20.68 BAR)

Rango de temperatura  
- 40° C a 149° C  
Temperature Range  
- 40° F to 300° F

Sujeto a cambios  
sin previo aviso  
Subject to change  
without notice

BHP = WHP + VHP  
BKW = WKW + VKW



Acceso "A" #103  
Fracc. Ind. Jurica  
Querétaro, Qro. México  
CP 76130  
+52 (442) 218 4570  
+52 (442) 103 3100  
Fax: +52 (442) 218 4577  
ventas@qpumps.com  
sales@qpumps.com  
www.qpumps.com

# Bombas de desplazamiento positivo ZP3

## ZP3 Series Positive Displacement Pumps

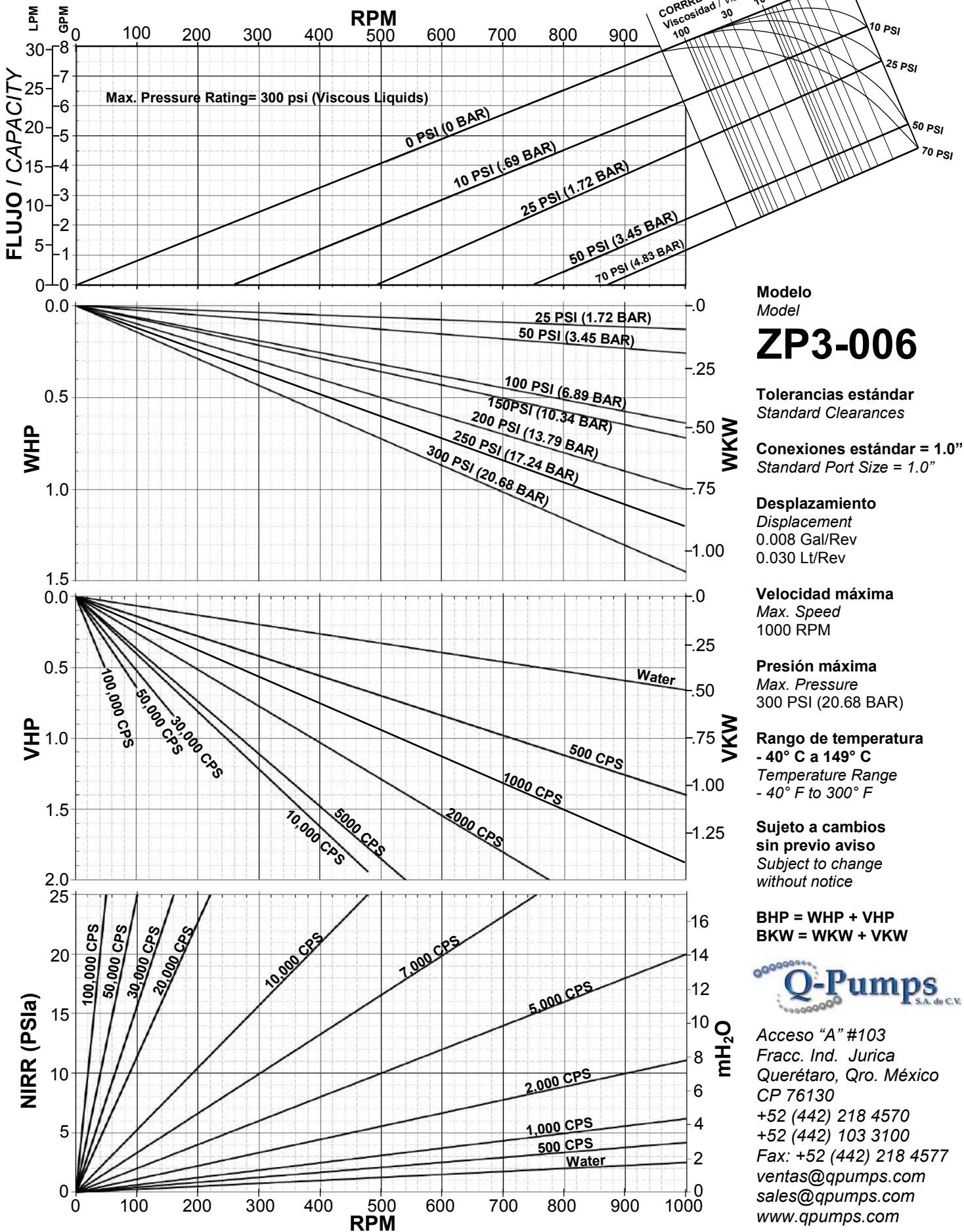

Modelo  
Model  
**ZP3-006**

Tolerancias estándar  
Standard Clearances

Conexiones estándar = 1.0"  
Standard Port Size = 1.0"

Desplazamiento  
Displacement  
0.008 Gal/Rev  
0.030 Lt/Rev

Velocidad máxima  
Max. Speed  
1000 RPM

Presión máxima  
Max. Pressure  
300 PSI (20.68 BAR)

Rango de temperatura  
- 40° C a 149° C  
Temperature Range  
- 40° F to 300° F

Sujeto a cambios  
sin previo aviso  
Subject to change  
without notice

**BHP = WHP + VHP**  
**BKW = WKW + VKW**



Acceso "A" #103  
Fracc. Ind. Jurica  
Querétaro, Qro. México  
CP 76130  
+52 (442) 218 4570  
+52 (442) 103 3100  
Fax: +52 (442) 218 4577  
ventas@qpumps.com  
sales@qpumps.com  
www.qpumps.com

# Bombas de desplazamiento positivo ZP3

## ZP3 Series Positive Displacement Pumps

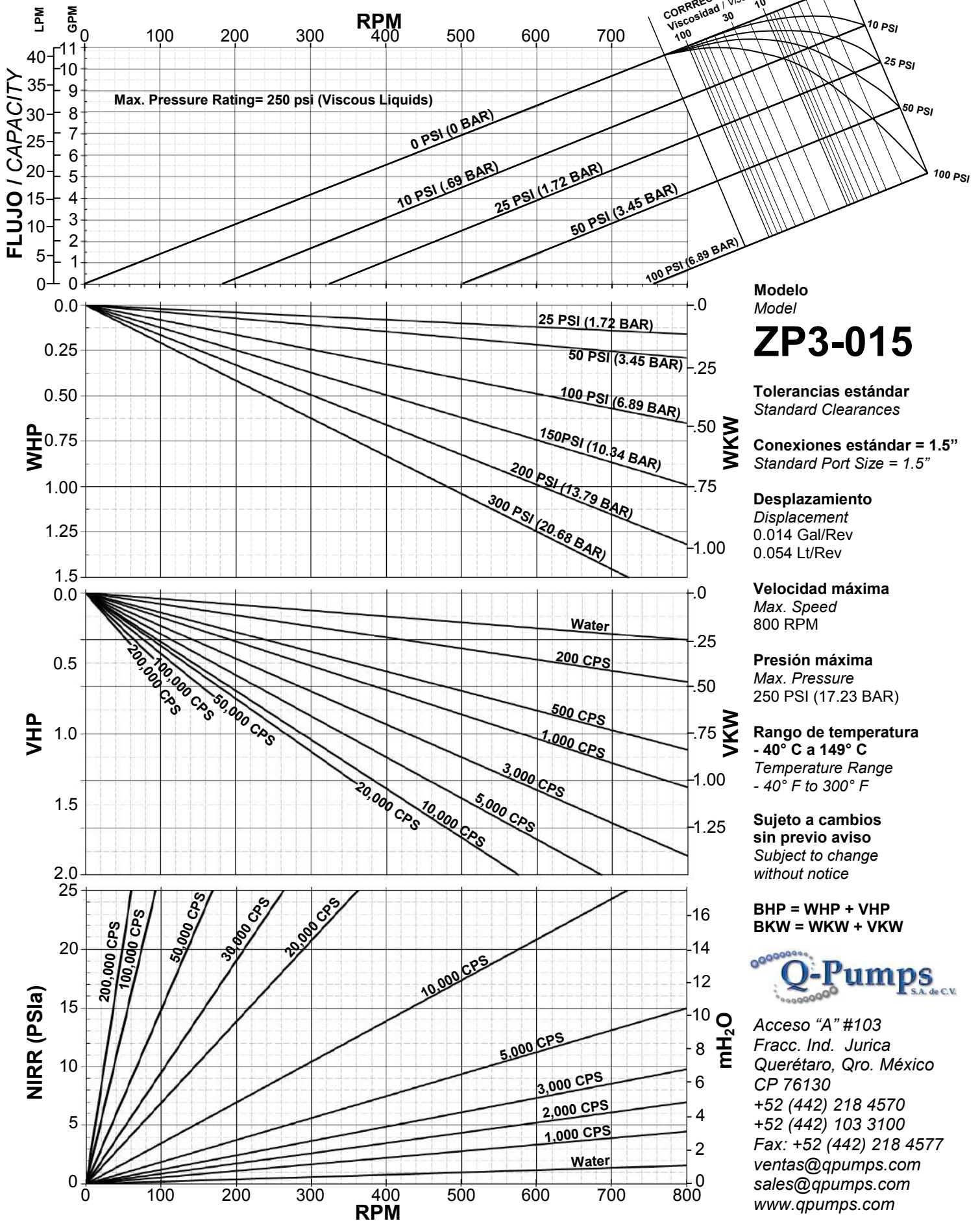

Modelo  
Model  
**ZP3-015**

Tolerancias estándar  
Standard Clearances

Conexiones estándar = 1.5"  
Standard Port Size = 1.5"

Desplazamiento  
Displacement  
0.014 Gal/Rev  
0.054 Lt/Rev

Velocidad máxima  
Max. Speed  
800 RPM

Presión máxima  
Max. Pressure  
250 PSI (17.23 BAR)

Rango de temperatura  
- 40° C a 149° C  
Temperature Range  
- 40° F to 300° F

Sujeto a cambios  
sin previo aviso  
Subject to change  
without notice

BHP = WHP + VHP  
BKW = WKW + VKW



Acceso "A" #103  
Fracc. Ind. Jurica  
Querétaro, Qro. México  
CP 76130  
+52 (442) 218 4570  
+52 (442) 103 3100  
Fax: +52 (442) 218 4577  
ventas@qpumps.com  
sales@qpumps.com  
www.qpumps.com

# Bombas de desplazamiento positivo ZP3

## ZP3 Series Positive Displacement Pumps

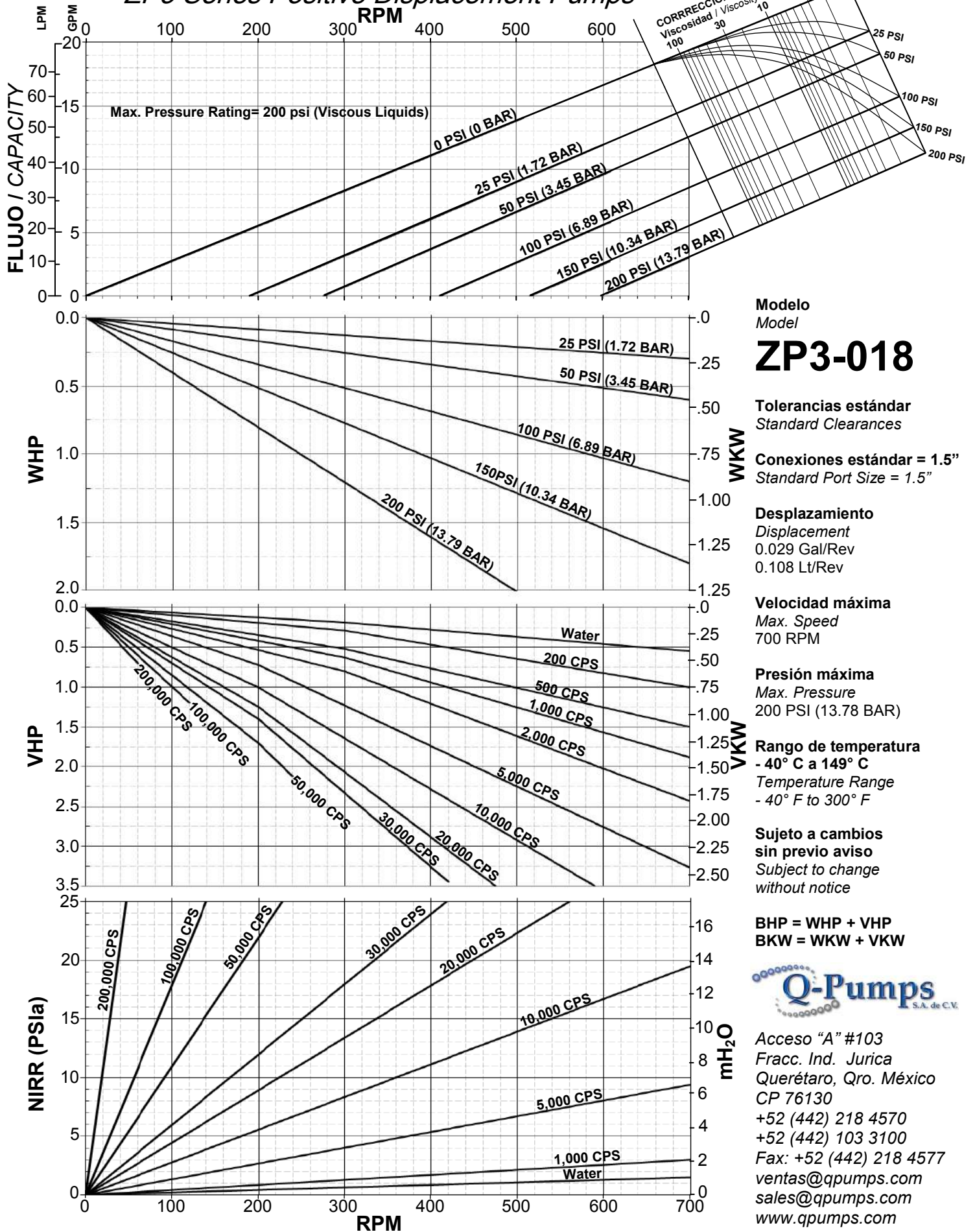

Max. Pressure Rating= 200 psi (Viscous Liquids)

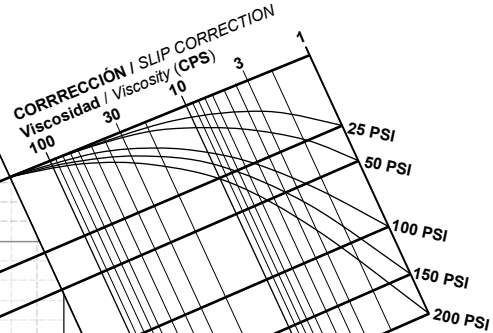

Modelo  
Model

# ZP3-018

Tolerancias estándar  
Standard Clearances

Conexiones estándar = 1.5"  
Standard Port Size = 1.5"

Desplazamiento  
Displacement  
0.029 Gal/Rev  
0.108 Lt/Rev

Velocidad máxima  
Max. Speed  
700 RPM

Presión máxima  
Max. Pressure  
200 PSI (13.78 BAR)

Rango de temperatura  
- 40° C a 149° C  
Temperature Range  
- 40° F to 300° F

Sujeto a cambios  
sin previo aviso  
Subject to change  
without notice

BHP = WHP + VHP  
BKW = WKW + VKW



Acceso "A" #103  
Fracc. Ind. Jurica  
Querétaro, Qro. México  
CP 76130  
+52 (442) 218 4570  
+52 (442) 103 3100  
Fax: +52 (442) 218 4577  
ventas@qpumps.com  
sales@qpumps.com  
www.qpumps.com

# Bombas de desplazamiento positivo ZP3

## ZP3 Series Positive Displacement Pumps

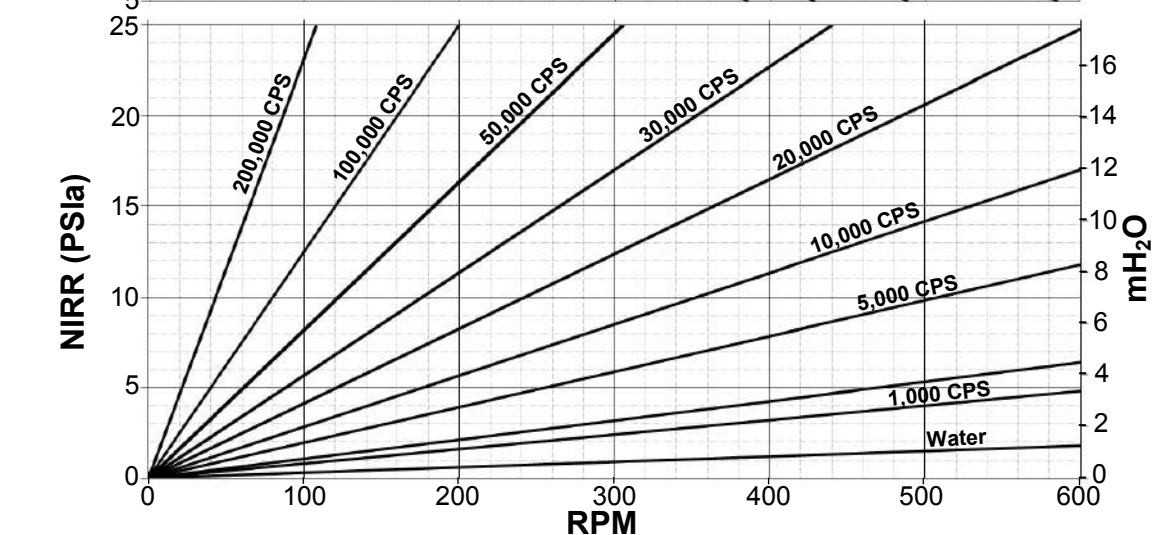
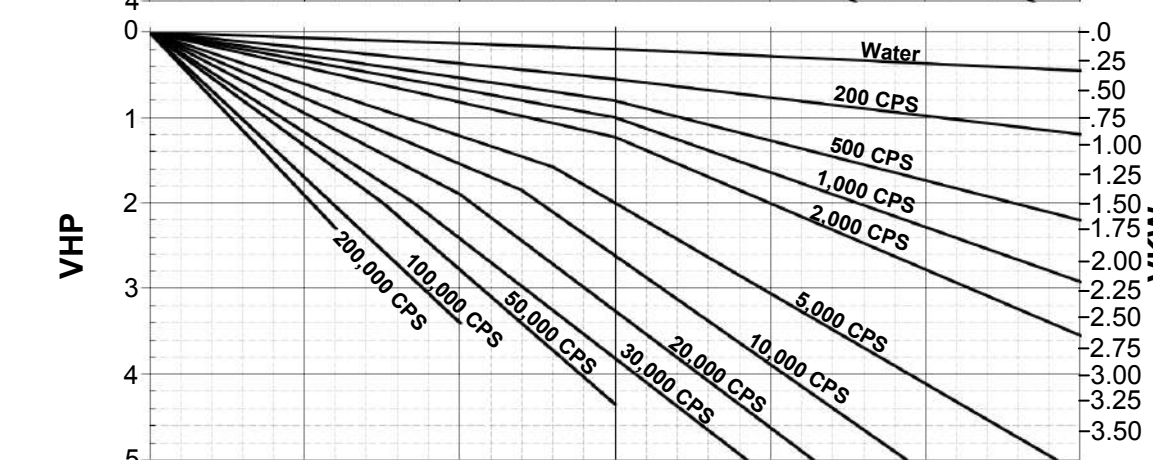
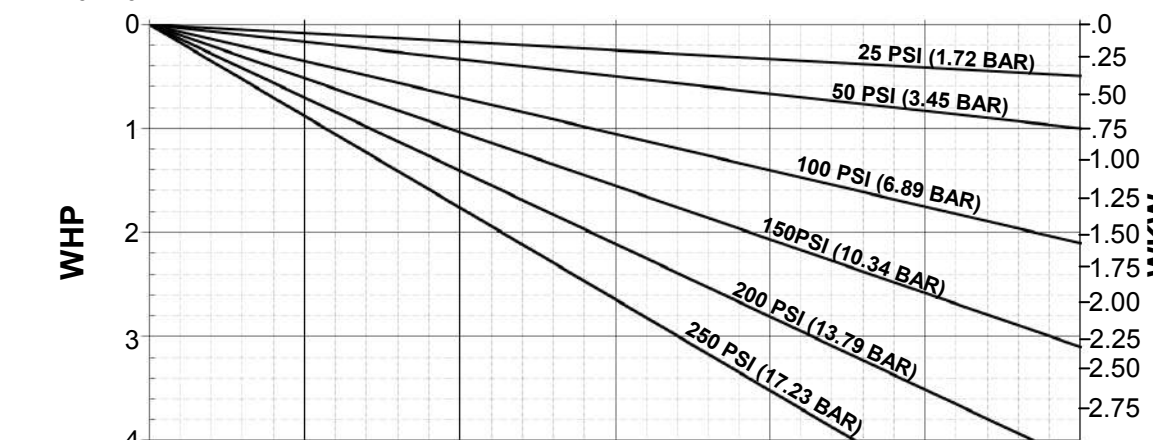
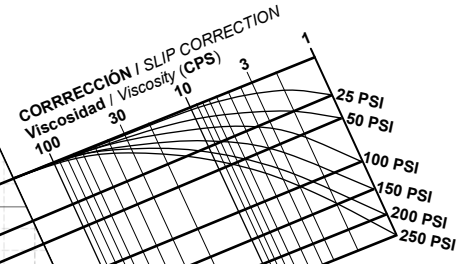
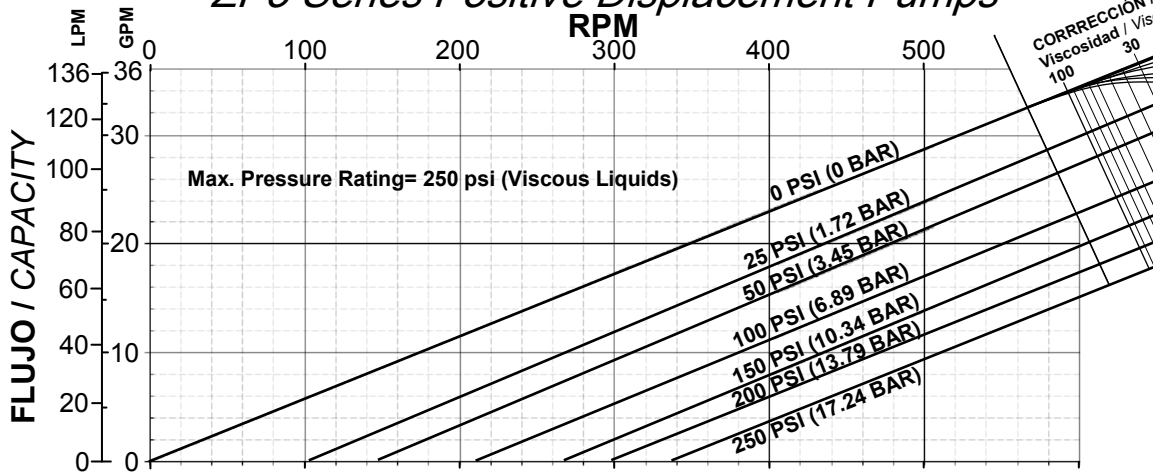

Modelo  
Model

# ZP3-030

Tolerancias estándar  
Standard Clearances

Conexiones estándar = 1.5"  
Standard Port Size = 1.5"

Desplazamiento  
Displacement  
0.060 Gal/Rev  
0.227 Lt/Rev

Velocidad máxima  
Max. Speed  
600 RPM

Presión máxima  
Max. Pressure  
250 PSI (17.23 BAR)

Rango de temperatura  
- 40° C a 149° C  
Temperature Range  
- 40° F to 300° F

Sujeto a cambios  
sin previo aviso  
Subject to change  
without notice

BHP = WHP + VHP  
BKW = WKW + VKW



Acceso "A" #103  
Fracc. Ind. Jurica  
Querétaro, Qro. México  
CP 76130  
+52 (442) 218 4570  
+52 (442) 103 3100  
Fax: +52 (442) 218 4577  
ventas@qpumps.com  
sales@qpumps.com  
www.qpumps.com

# Bombas de desplazamiento positivo ZP3

## ZP3 Series Positive Displacement Pumps

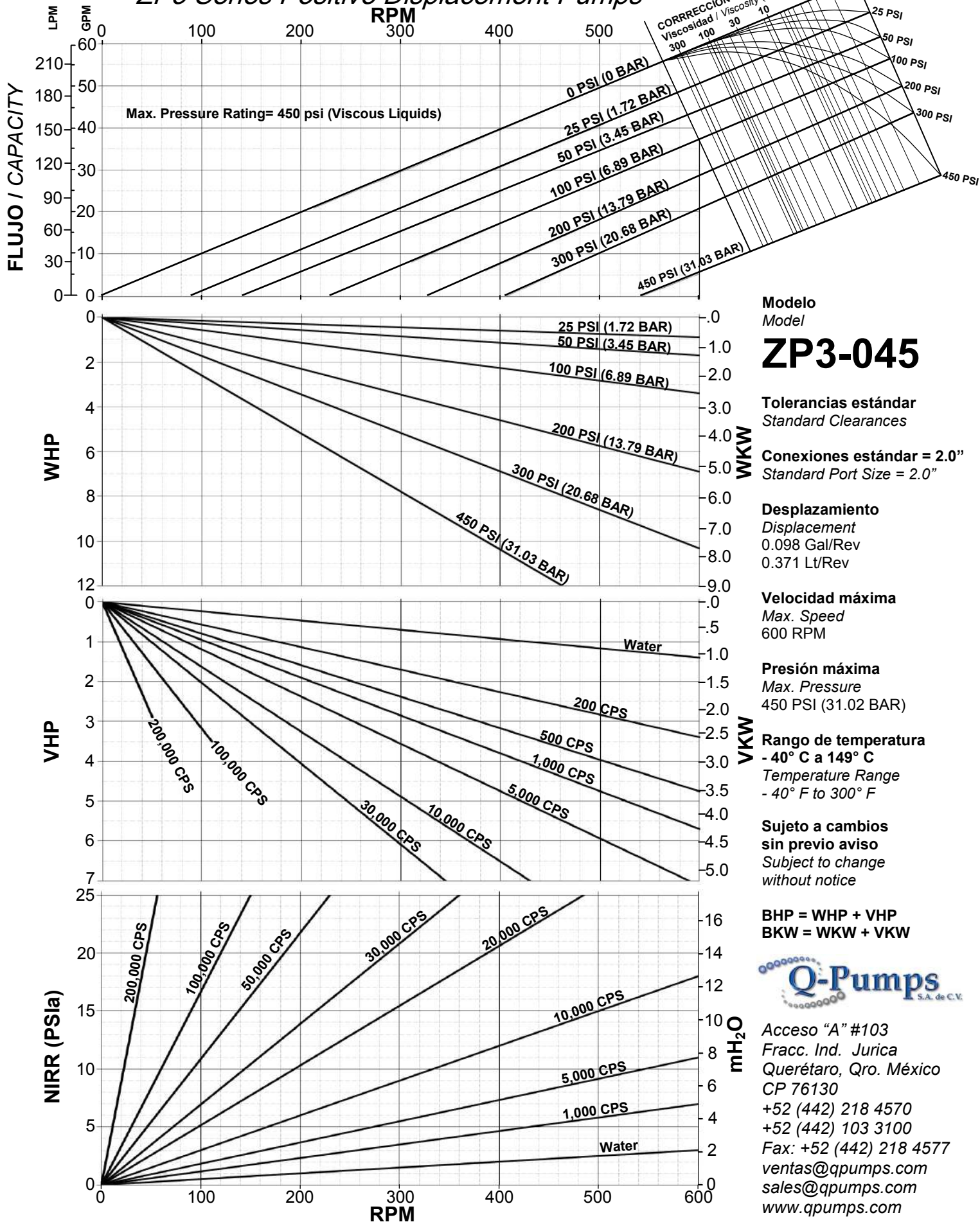

Max. Pressure Rating= 450 psi (Viscous Liquids)

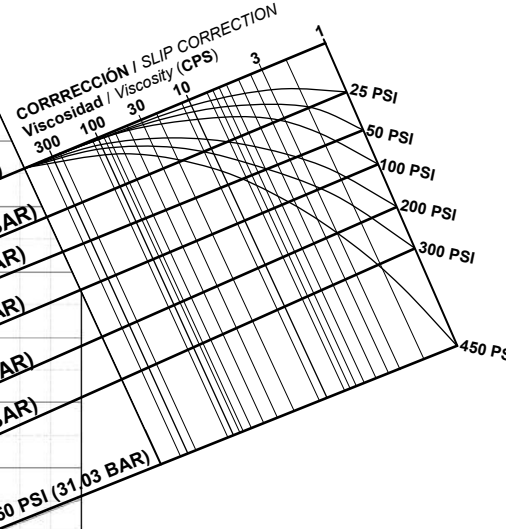

Modelo  
 Model  
**ZP3-045**

Tolerancias estándar  
 Standard Clearances

Conexiones estándar = 2.0"  
 Standard Port Size = 2.0"

Desplazamiento  
 Displacement  
 0.098 Gal/Rev  
 0.371 Lt/Rev

Velocidad máxima  
 Max. Speed  
 600 RPM

Presión máxima  
 Max. Pressure  
 450 PSI (31.02 BAR)

Rango de temperatura  
 - 40° C a 149° C  
 Temperature Range  
 - 40° F to 300° F

Sujeto a cambios  
 sin previo aviso  
 Subject to change  
 without notice

**BHP = WHP + VHP**  
**BKW = WKW + VKW**



Acceso "A" #103  
 Fracc. Ind. Jurica  
 Querétaro, Qro. México  
 CP 76130  
 +52 (442) 218 4570  
 +52 (442) 103 3100  
 Fax: +52 (442) 218 4577  
 ventas@qpumps.com  
 sales@qpumps.com  
 www.qpumps.com



# Bombas de desplazamiento positivo ZP3

## ZP3 Series Positive Displacement Pumps

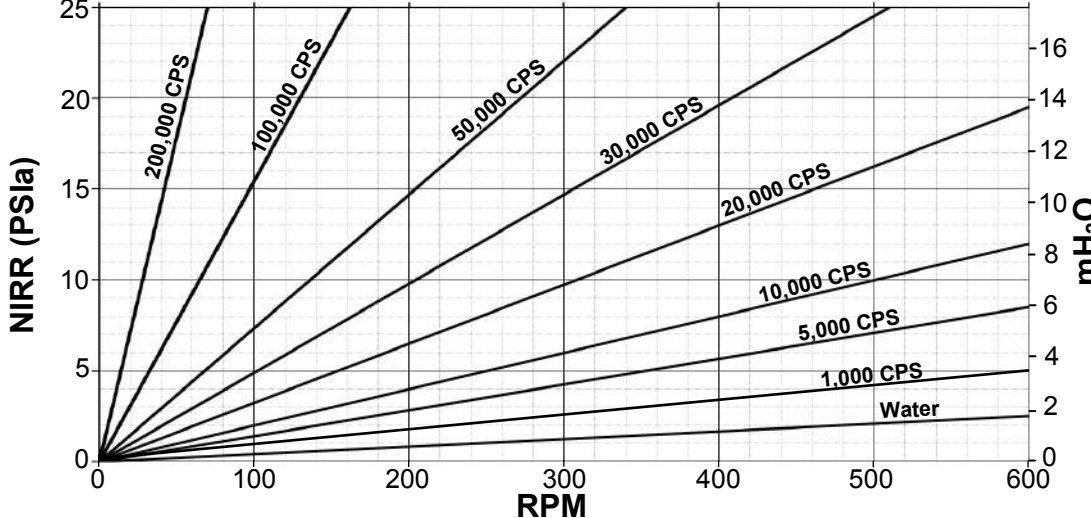
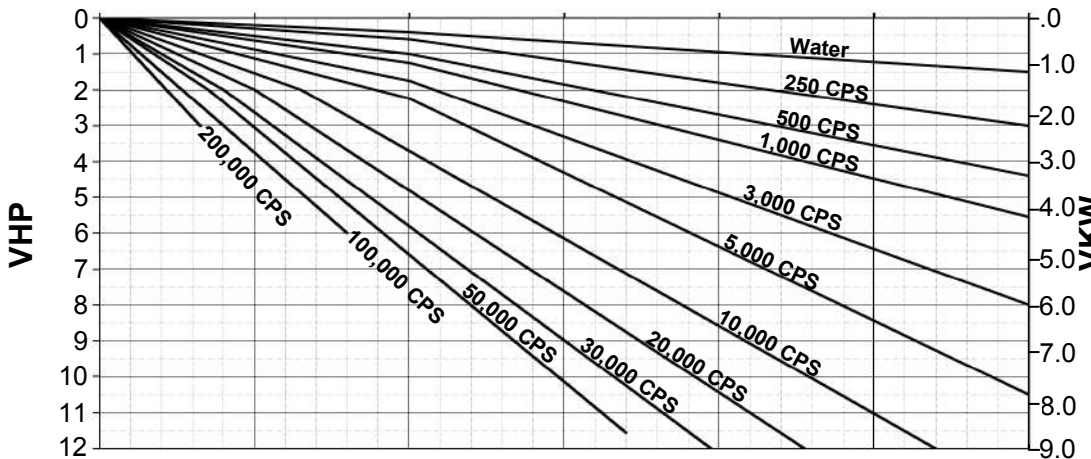
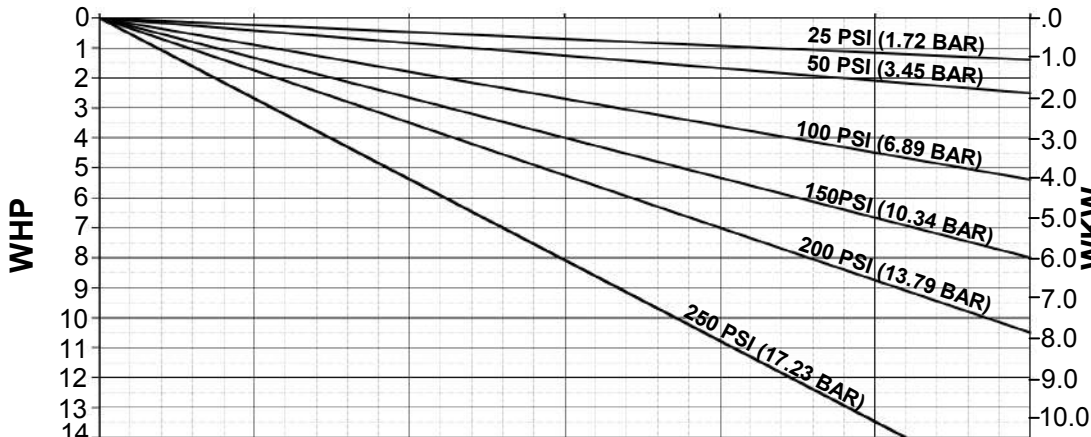
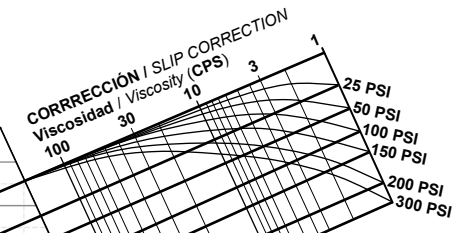
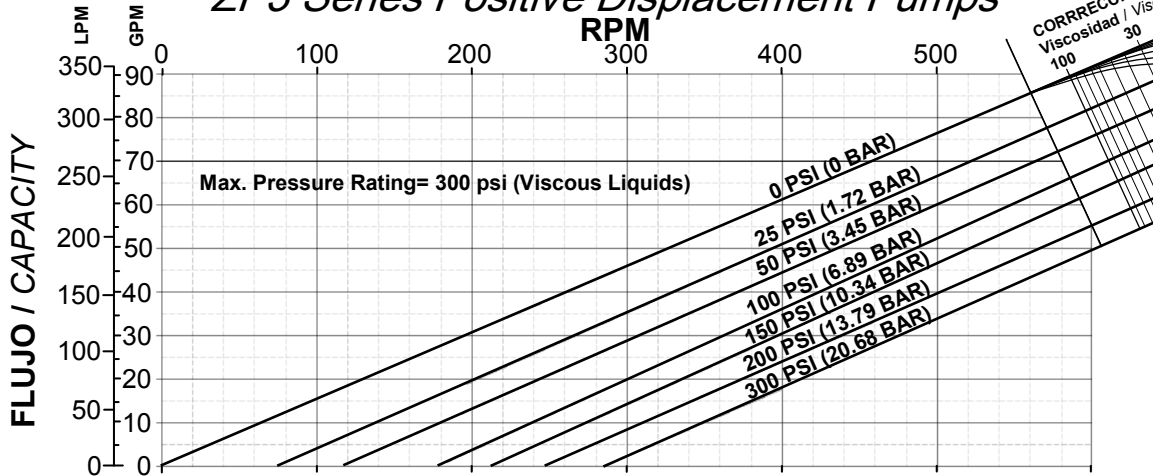

Modelo  
Model  
**ZP3-060**

Tolerancias estándar  
Standard Clearances

Conexiones estándar = 2.5"  
Standard Port Size = 2.5"

Desplazamiento  
Displacement  
0.153 Gal/Rev  
0.579 Lt/Rev

Velocidad máxima  
Max. Speed  
600 RPM

Presión máxima  
Max. Pressure  
300 PSI (20.68 BAR)

Rango de temperatura  
- 40° C a 149° C  
Temperature Range  
- 40° F to 300° F

Sujeto a cambios  
sin previo aviso  
Subject to change  
without notice

BHP = WHP + VHP  
BKW = WKW + VKW



Acceso "A" #103  
Fracc. Ind. Jurica  
Querétaro, Qro. México  
CP 76130  
+52 (442) 218 4570  
+52 (442) 103 3100  
Fax: +52 (442) 218 4577  
ventas@qpumps.com  
sales@qpumps.com  
www.qpumps.com

# Bombas de desplazamiento positivo ZP3

## ZP3 Series Positive Displacement Pumps

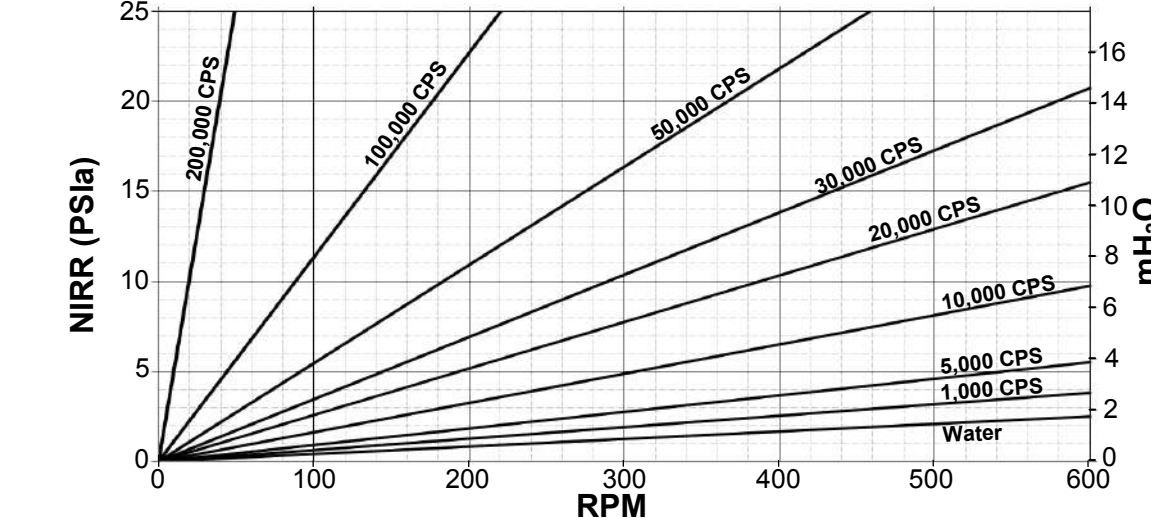
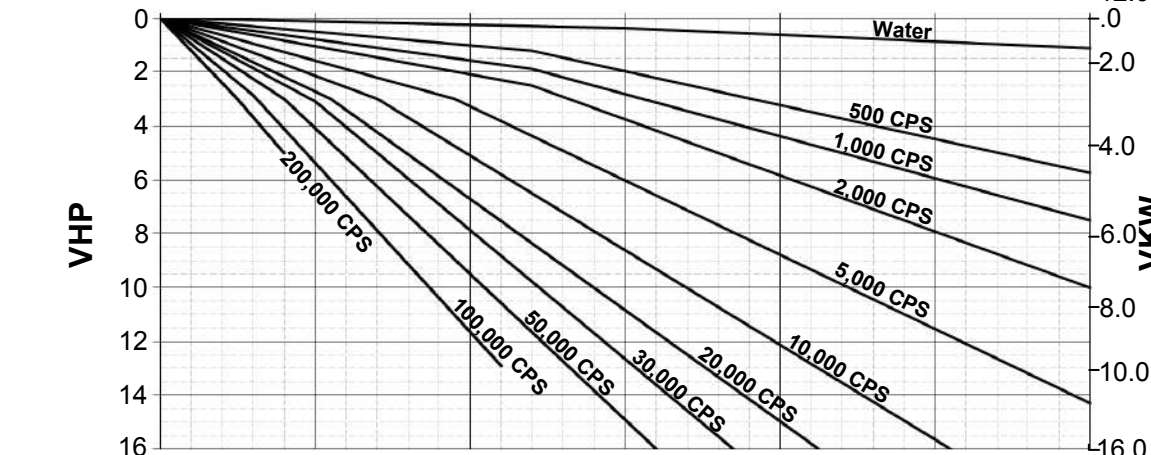
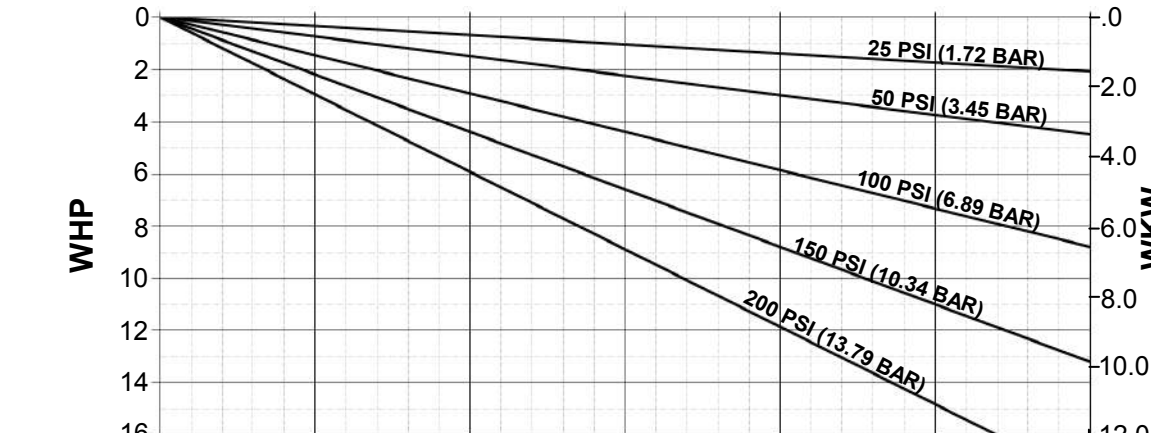
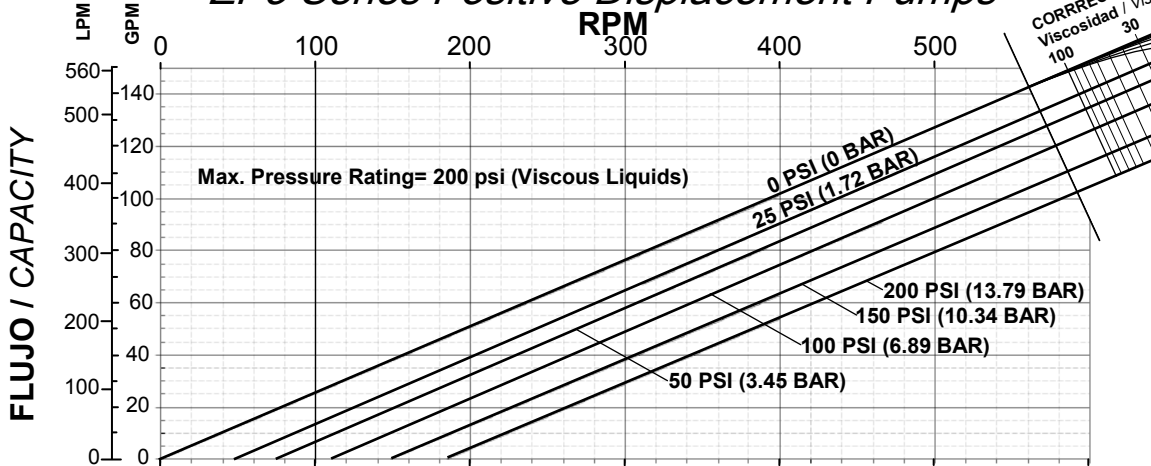

**Modelo**  
 Model  
**ZP3-130**

**Tolerancias estándar**  
 Standard Clearances

**Conexiones estándar = 3.0"**  
 Standard Port Size = 3.0"

**Desplazamiento**  
 Displacement  
 0.253 Gal/Rev  
 0.958 Lt/Rev

**Velocidad máxima**  
 Max. Speed  
 600 RPM

**Presión máxima**  
 Max. Pressure  
 200 PSI (13.78 BAR)

**Rango de temperatura**  
 - 40° C a 149° C  
 Temperature Range  
 - 40° F to 300° F

**Sujeto a cambios sin previo aviso**  
 Subject to change without notice

**BHP = WHP + VHP**  
**BKW = WKW + VKW**



Acceso "A" #103  
 Fracc. Ind. Jurica  
 Querétaro, Qro. México  
 CP 76130  
 +52 (442) 218 4570  
 +52 (442) 103 3100  
 Fax: +52 (442) 218 4577  
 ventas@qpumps.com  
 sales@qpumps.com  
 www.qpumps.com

# Bombas de desplazamiento positivo ZP3

## ZP3 Series Positive Displacement Pumps

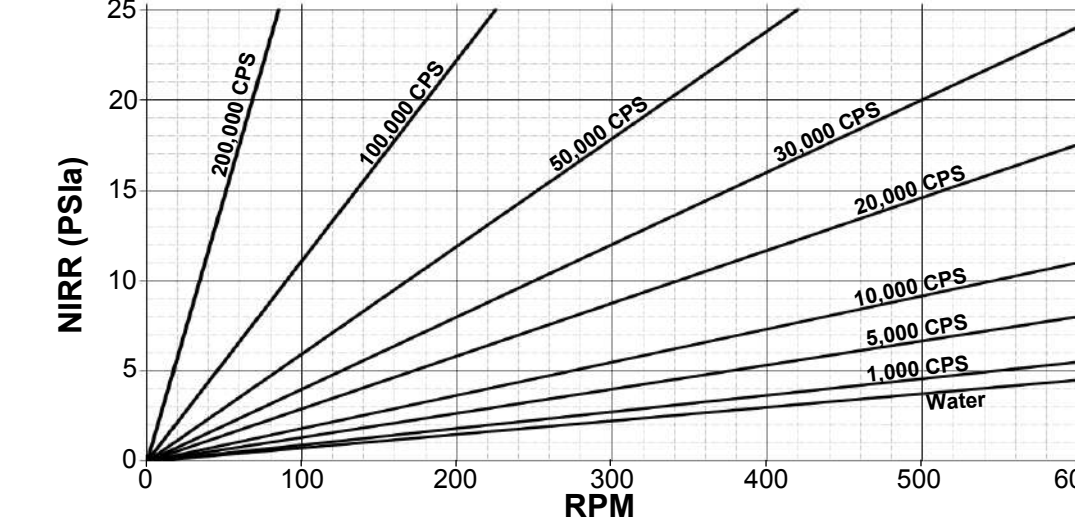
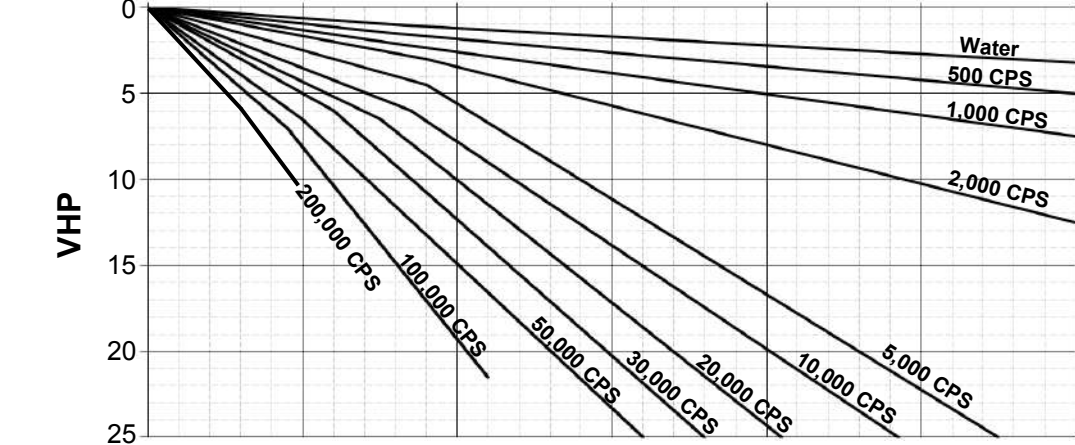
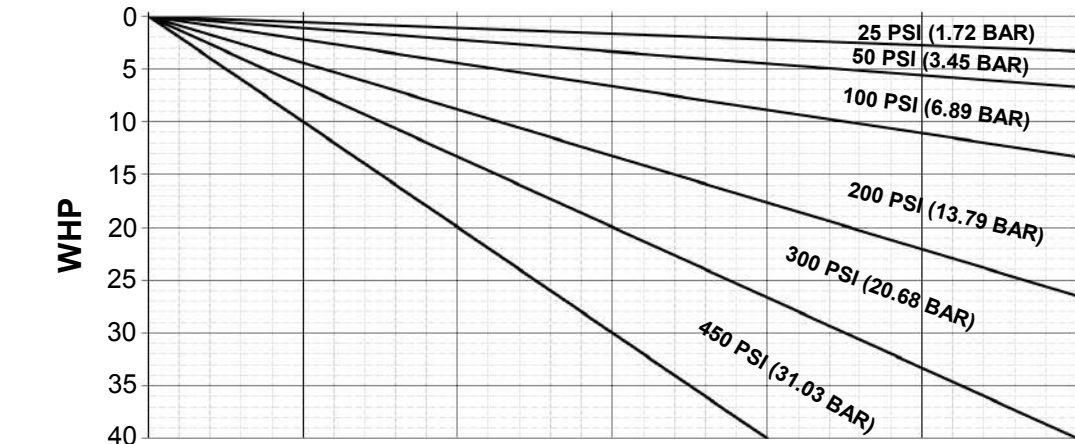
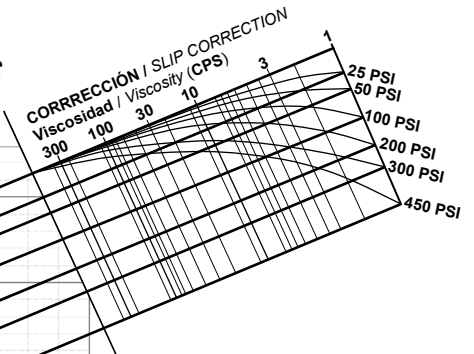
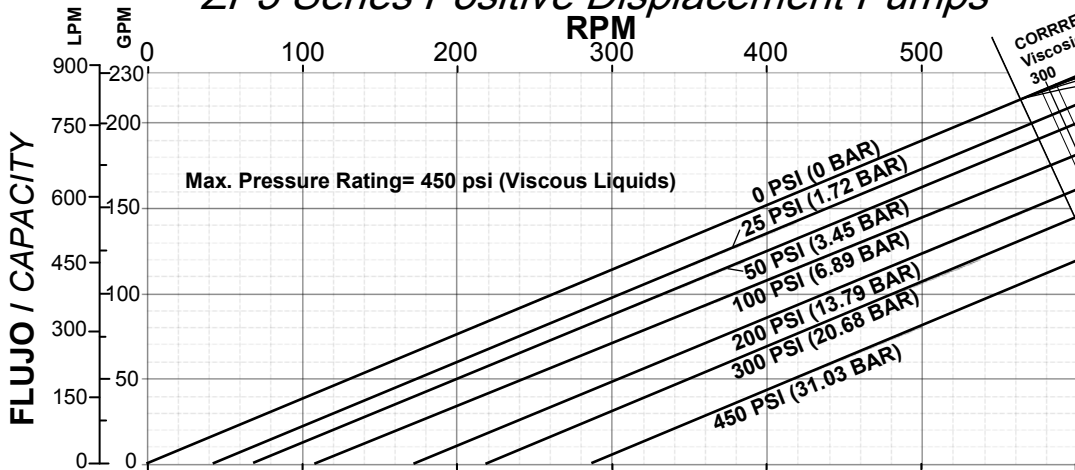

Modelo  
Model  
**ZP3-180**

Tolerancias estándar  
Standard Clearances

Conexiones estándar = 3.0"  
Standard Port Size = 3.0"

Desplazamiento  
Displacement  
0.380 Gal/Rev  
1.438 Lt/Rev

Velocidad máxima  
Max. Speed  
600 RPM

Presión máxima  
Max. Pressure  
450 PSI (31.02 BAR)

Rango de temperatura  
- 40° C a 149° C  
Temperature Range  
- 40° F to 300° F

Sujeto a cambios  
sin previo aviso  
Subject to change  
without notice

BHP = WHP + VHP  
BKW = VKW + VKW



Acceso "A" #103  
Fracc. Ind. Jurica  
Querétaro, Qro. México  
CP 76130  
+52 (442) 218 4570  
+52 (442) 103 3100  
Fax: +52 (442) 218 4577  
ventas@qpumps.com  
sales@qpumps.com  
www.qpumps.com

# Bombas de desplazamiento positivo ZP3

## ZP3 Series Positive Displacement Pumps

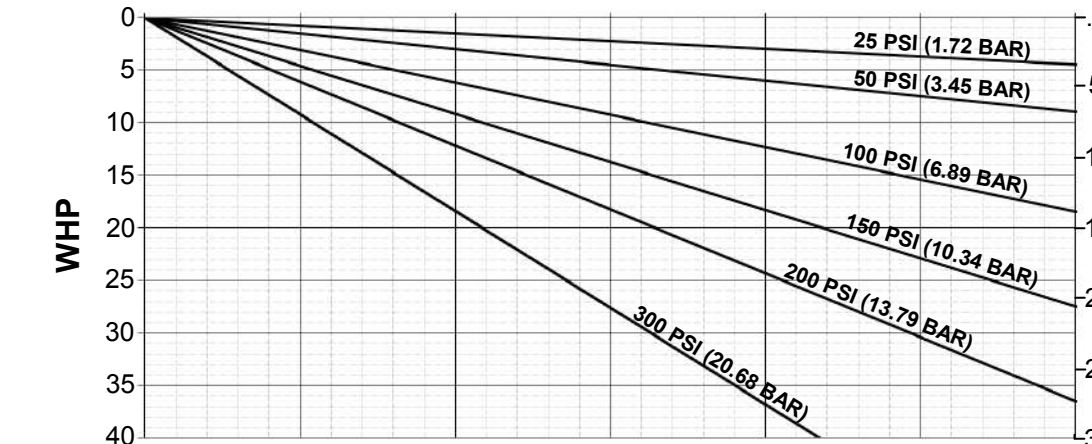
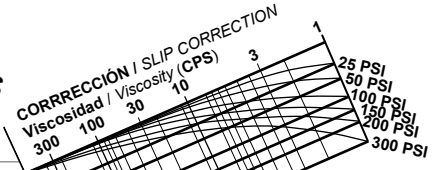
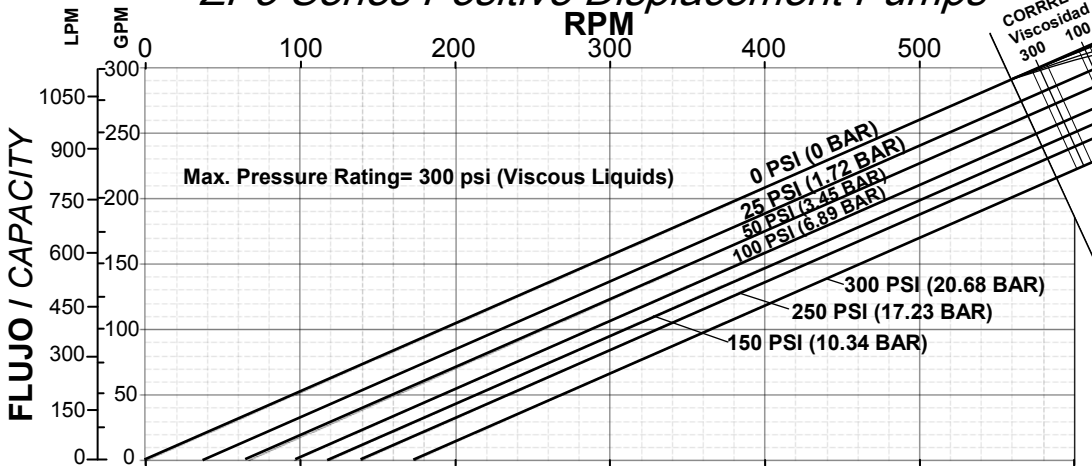

Modelo  
 Model  
**ZP3-220**

Tolerancias estándar  
 Standard Clearances

Conexiones estándar = 4.0"  
 Standard Port Size = 4.0"

Desplazamiento  
 Displacement  
 0.521 Gal/Rev  
 1.972 Lt/Rev

Velocidad máxima  
 Max. Speed  
 600 RPM

Presión máxima  
 Max. Pressure  
 300 PSI (20.68 BAR)

Rango de temperatura  
 - 40° C a 149° C  
 Temperature Range  
 - 40° F to 300° F

Sujeto a cambios  
 sin previo aviso  
 Subject to change  
 without notice

BHP = WHP + VHP  
 BKW = WKW + VKW

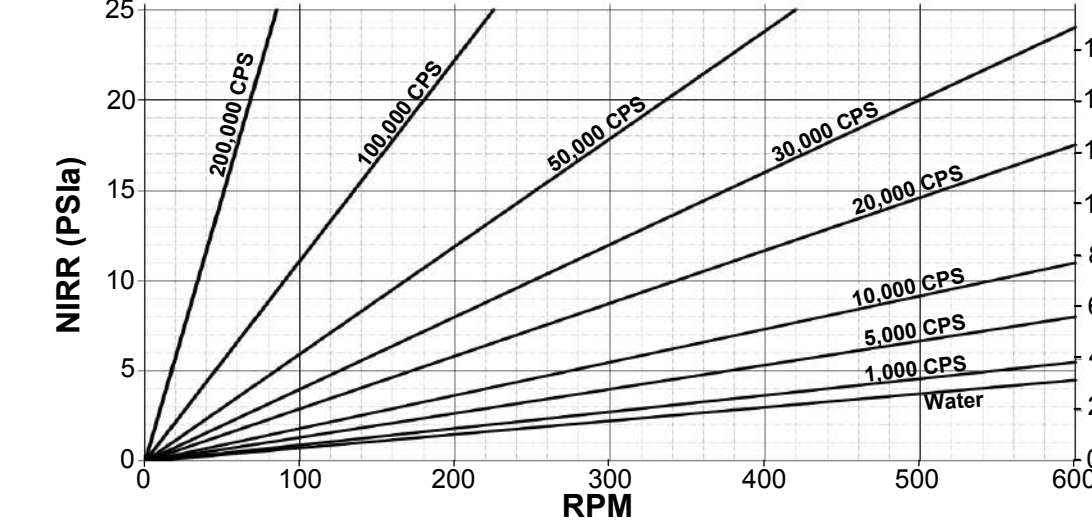
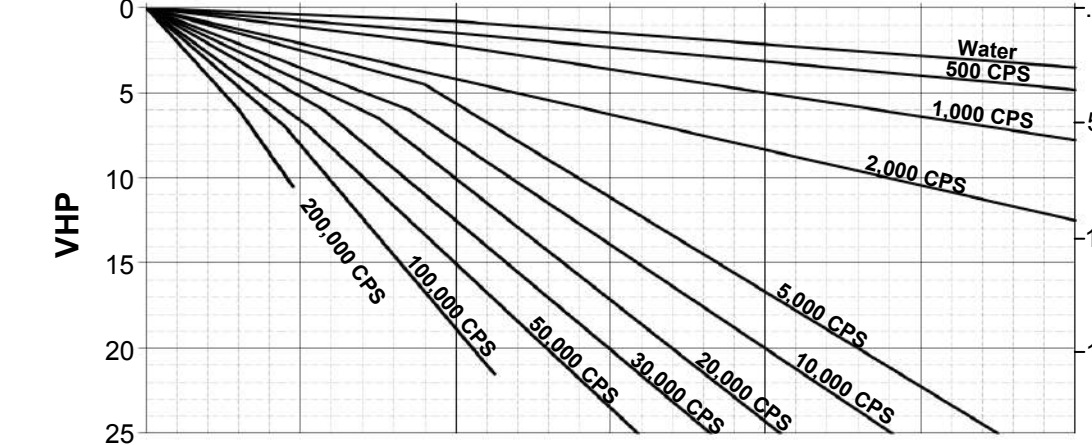

Acceso "A" #103  
 Fracc. Ind. Jurica  
 Querétaro, Qro. México  
 CP 76130  
 +52 (442) 218 4570  
 +52 (442) 103 3100  
 Fax: +52 (442) 218 4577  
 ventas@qpumps.com  
 sales@qpumps.com  
 www.qpumps.com